

okidoki



ThinkingWorks

okidoki

Okidoki was born from the idea of creating a table and chair family which can easily transition from home to office, with the cheeky, fun design bringing a sense of informality to the chosen environment. Featuring solid timber legs in American Ash, Walnut Stain, Black Stain or White Stain, the timber colour range of the legs is designed to either compliment or contrast with the powdercoat colours of the steel and aluminium framework.

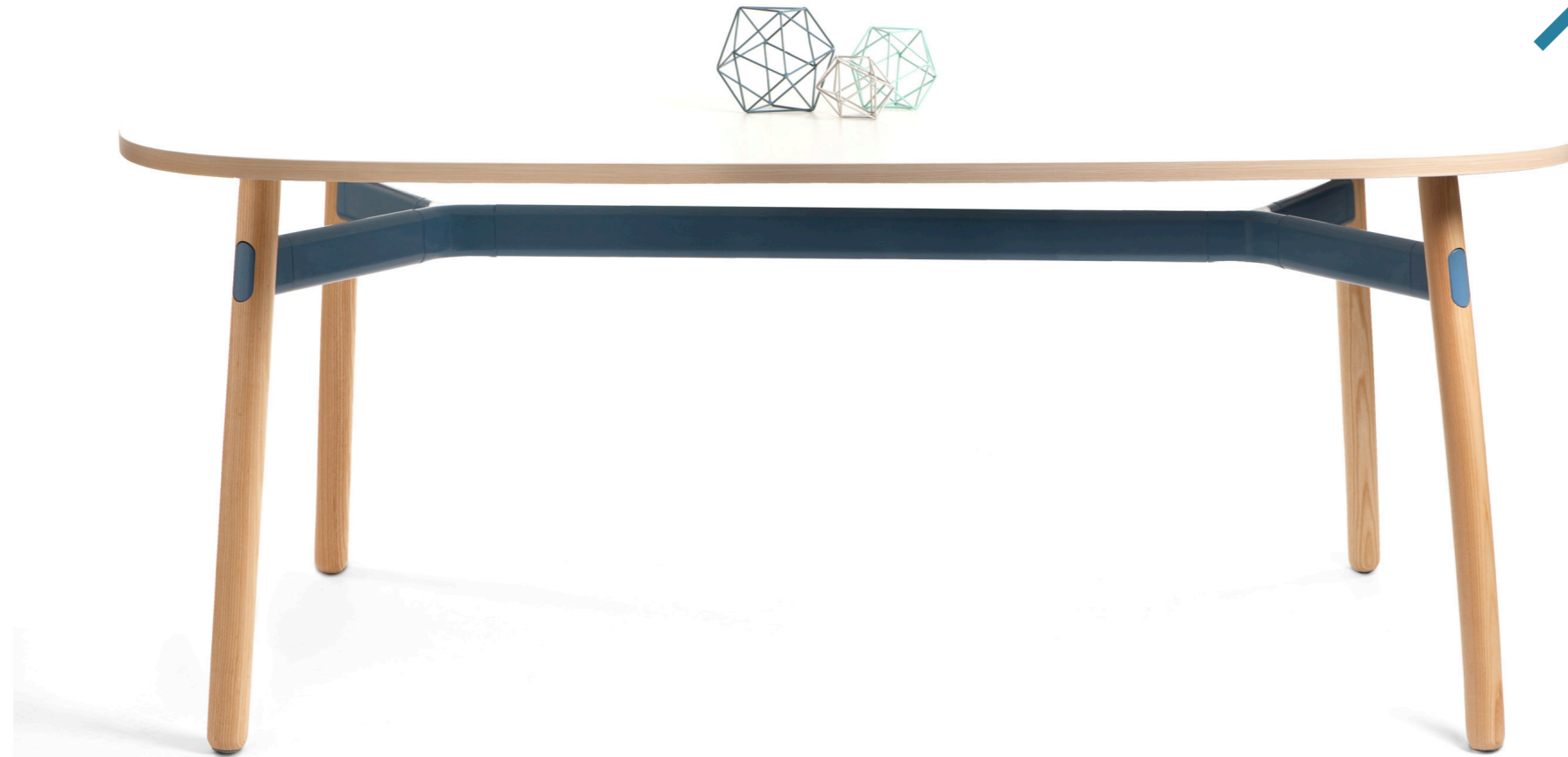

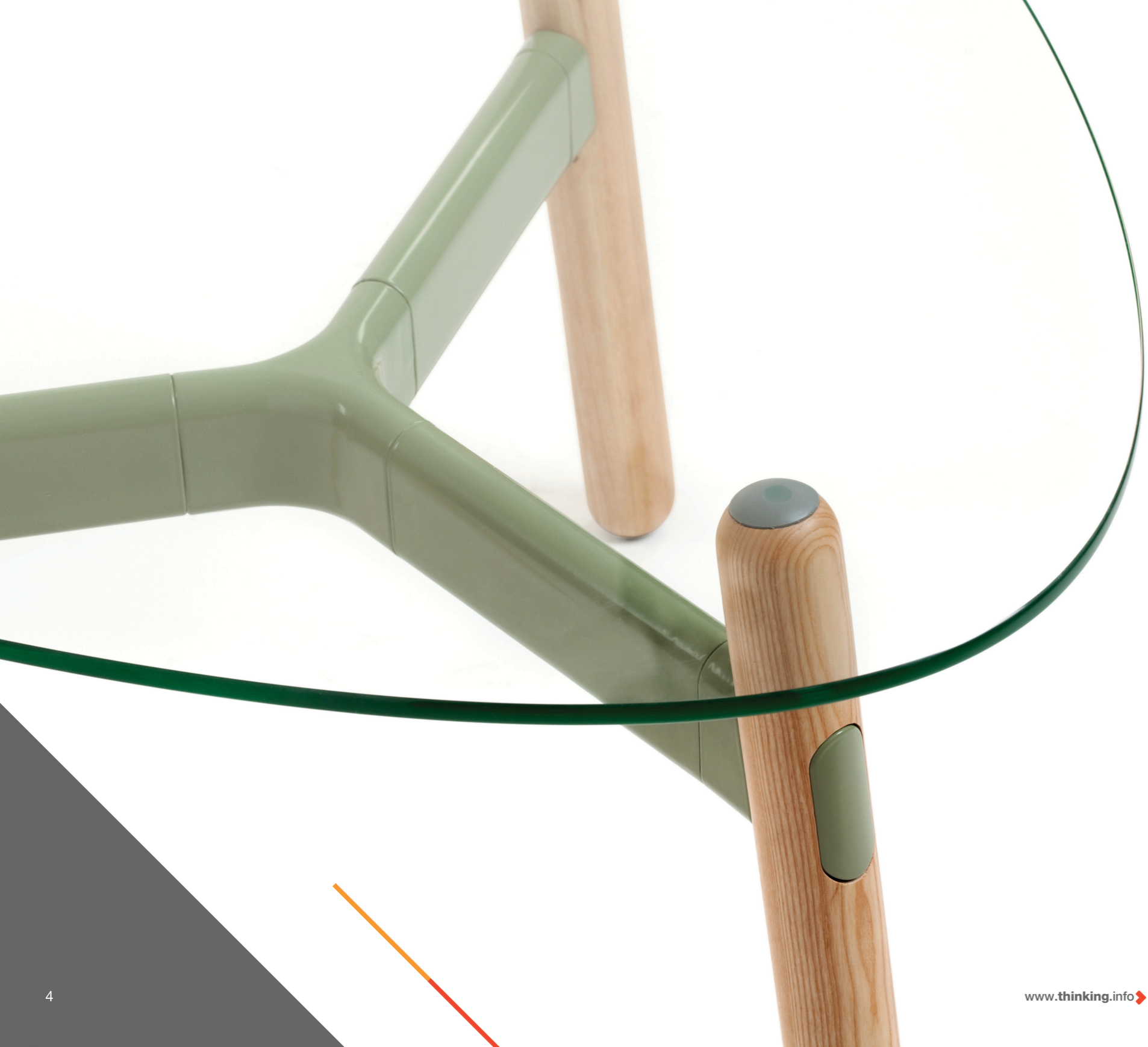

The tables have been developed in consideration of the natural material selection and rounded design theme of the table frame. Okidoki features table tops in round, rounded square/rectangle and rounded triangular shapes in either timber finish or glass (which shows off the clean design of the table frame).

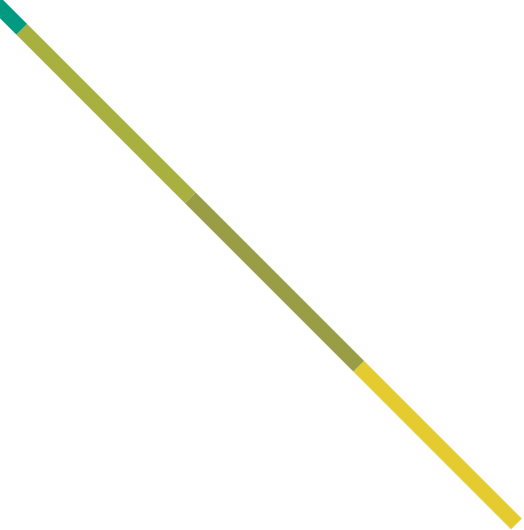

 SPECIFICATIONS

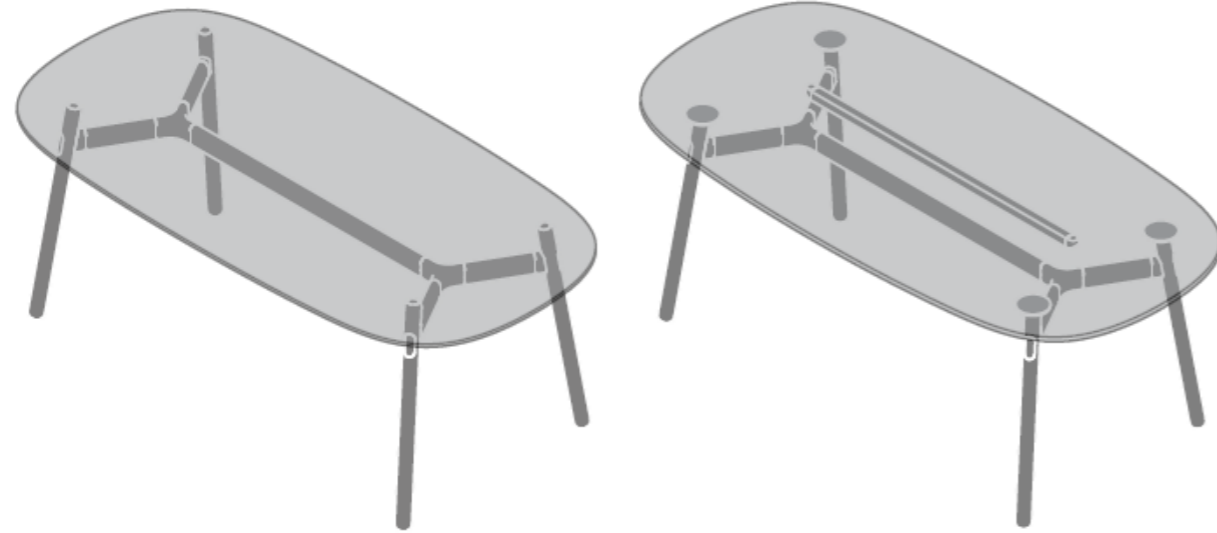

OKD-1018
1800 x 900mm Glass / Timber
Rounded Rectangle

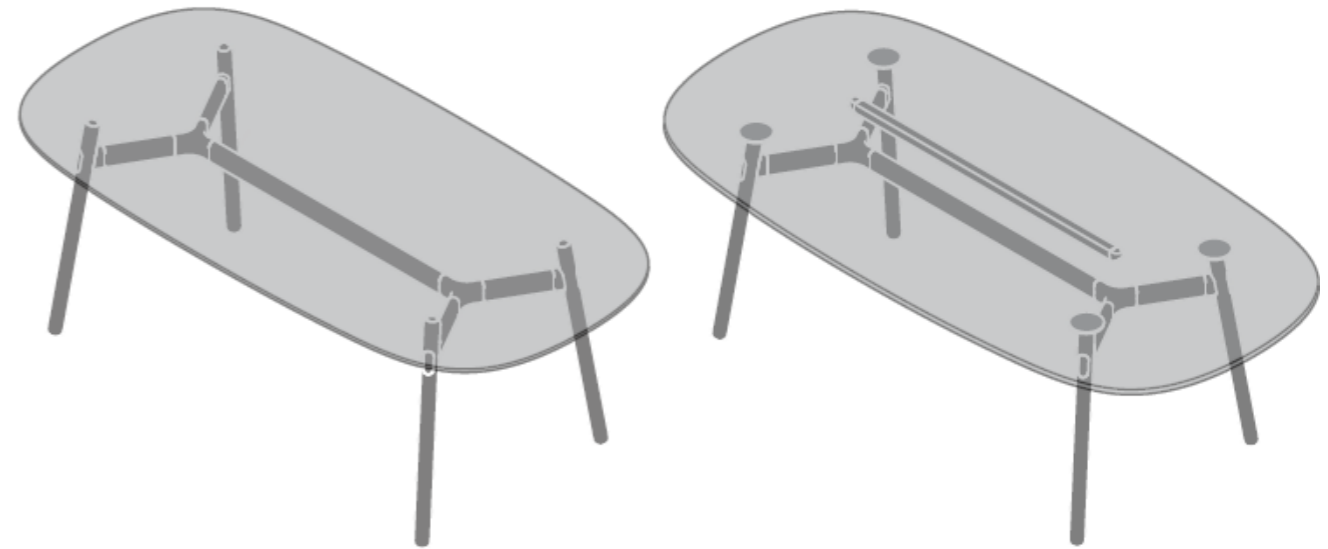

OKD-1021
2100 x 1050mm Glass / Timber
Rounded Rectangle

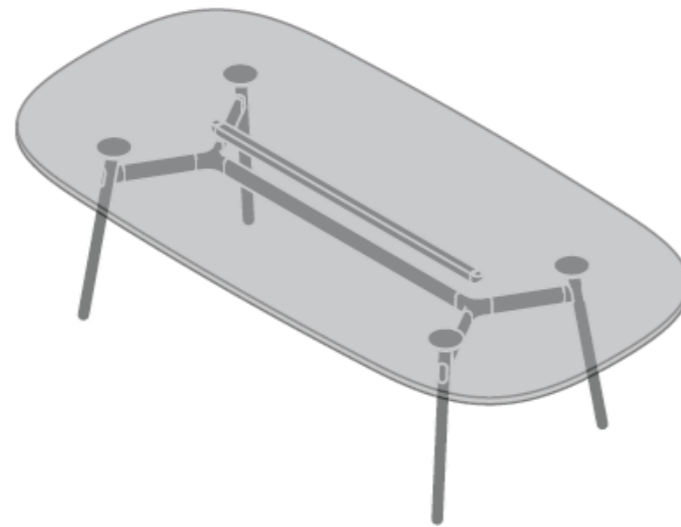

OKD-1024
2400 x 1200mm
Rounded Rectangle



OKD-1518 Standing Height
1800 x 900mm Rounded Rectangle
Standing Height



SPECIFICATIONS

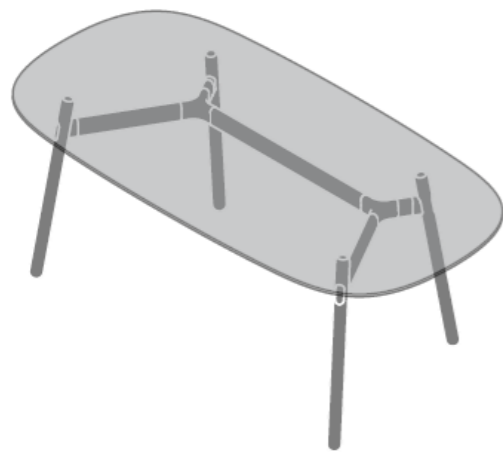

OKD-1218
1800 x 900mm Glass / Timber
Rounded Rectangle Desk

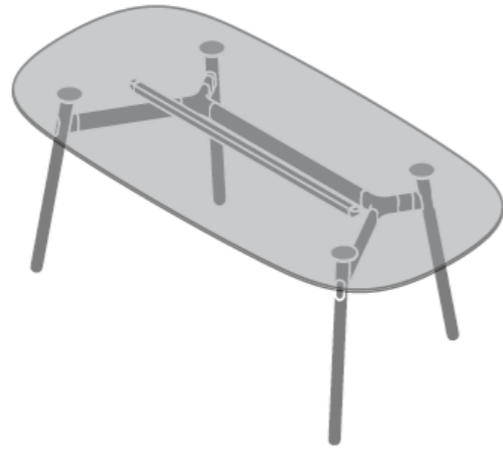

OKD-1070
1050mm Glass / Timber
Rounded Square



OKD-1570
1050mm Rounded Square
Standing Height



OKD-1061
1200mm Glass / Timber
Rounded Triangle



OKD-1560
800mm Rounded Triangle
Standing Height



OKD-1561
1200mm Rounded Triangle
Standing Height

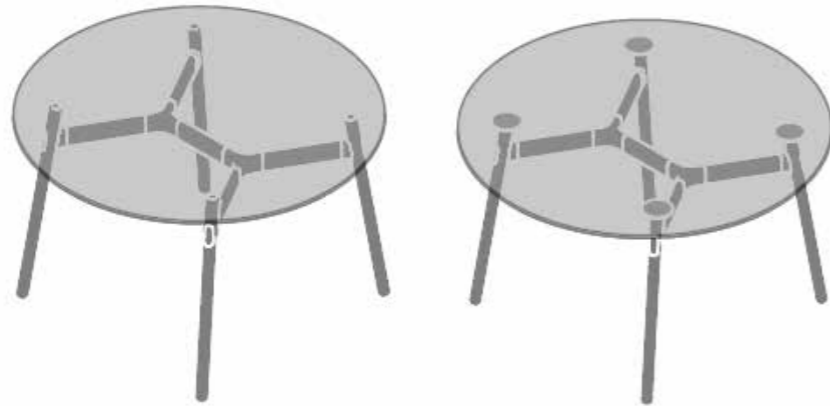

OKD-1070
1200mm dia Glass / Timber
Round



OKD-1570
1200mm dia Round
Standing Height

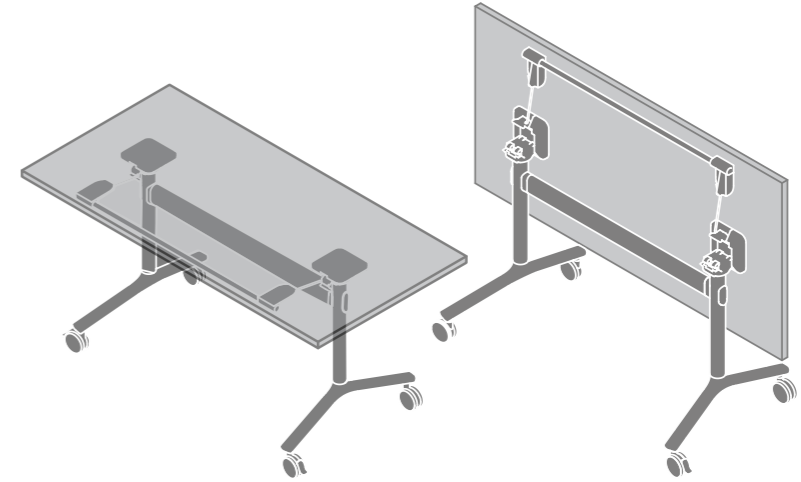

OKD-1080 / OKD-1082 / OKD-1084 / ODK 1086
Folding Rectangle

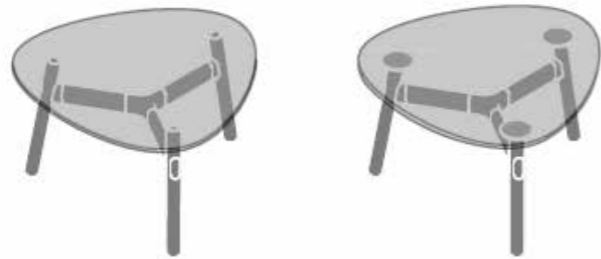

OKD-1060
800mm Glass / Timber
Rounded Triangle Coffee Table

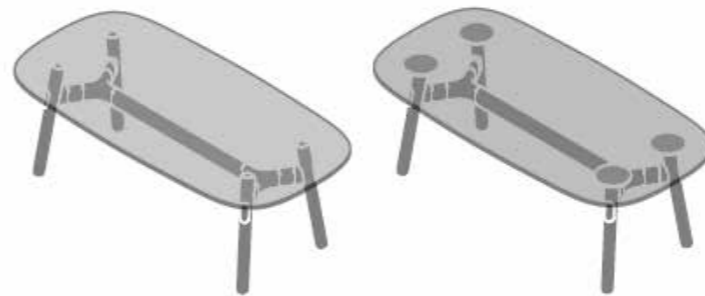

OKD-1012
1200 x 600mm Glass / Timber
Rounded Rectangle Coffee Table



Okidoki Timber Legs
 Ash - Standard
 Premium Stain - Walnut, Black, White

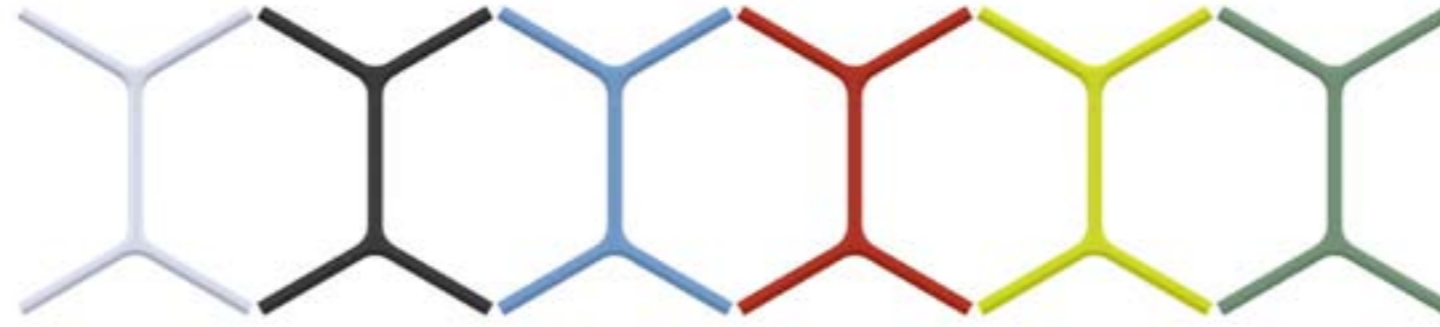

Powdercoat Frame Colours
 Satin White - Standard
 Premium 1 Powdercoat colours - Matte Black / Wedgewood / Signal Red / Lemon Yellow / Pale Eucalypt



Folding Table Legs
 Satin White Powdercoat - Standard
 Premium 1 Powdercoat colours
 Premium 2 Timber grain Powdercoat



Melamine Table Tops
 White / Pillar Box / Olive / Steel Blue / Black
 (Available in 25mm square edge)



Melamine Edging
 Timber grain 2mm ABS edging
 Matching 2mm ABS edging (worktop colour)



Glass Table Tops
 Clear / Black Tinted
 (Available in 10mm flat polished edge)

TABLES

Acting sustainably is what we do. With our beginnings in Australia, since 1984 we have been designing and manufacturing commercial furniture products and components for global work place environments. With sustainability at the core of everything we do, we are dedicated to the reduction of environmental impact from our products and actions.

Because **ThinkingWorks**

Okidoki designed by ThinkingWorks Design Studio.



ThinkingWorks

www.thinking.info

Asia, Australia & New Zealand. Europe & United Kingdom.