

framery

The Shape of Silence ⁷







A person in a dark jacket and pants stands on a wet beach, looking out at the ocean. Large waves are crashing onto the shore, creating a misty spray. The sky is overcast and grey.

*Imagine being able to focus
on the things you want to achieve.*

*Imagine being able to communicate clearly
– in privacy and silence.*

Soundscapes of open-plan offices are frequently too chaotic for our mind to handle and we tend to get stressed.
When we can focus on the right things, when our words and thoughts are understood without distractions –
only then we have a chance to bloom and prosper.

Framery is here to adjust the most visible wall of every space – the sound.



Creating Happy Workplaces.



Simple things change the world

When my girlfriend and I were students, we traveled back to school on Sundays. My mother used to pack a juicy orange for a snack. It was nice to eat an orange in the train. My orange peels would drop on the floor and the orange juice dripped onto my shirt. My girlfriend didn't have the same problem: her mother put an orange into a bag, the orange already had cuttings in the peel. The bag also included a napkin to wipe her fingers. She peeled her orange nicely, ate it, put the orange peels and the napkin back into the same bag, and threw it into the trash bin.

This experience made me realise something essential about design – especially, service design. Simple things can be made in various ways: by making a mess – or with style and ease.

Pekka

Pekka Toivola
PRODUCT DESIGNER
pekka.toivola@frameryacoustics.com





Our design philosophy

Swimming against the current is not an absolute value for us, but by doing things in our own way, we are able to see the world differently and make observations that nobody else has made.

We are able to come up with designs that are both simple and clever. Instead of looking at what our rivals are coming up with, we work with our customers to learn what they are doing, how they work and what makes them tick. We refuse to make bad compromises. We favour the efficient use of sustainable high-quality materials and we always put user experience first.

Samu Hällfors
EXECUTIVE VICE PRESIDENT, HEAD OF DESIGN
samu.hallfors@frameryacoustics.com

FRAMERY O

Great thoughts thrive in silence

Framery O is perfect for making important calls, participating in video conferences and having quiet space to focus on demanding tasks.

Framery O is ready to use without hours or days of construction. The booth includes all the equipment you need to make things easy – a table top, air ventilation system, electric socket and LED lighting. Framery O delivers an echo-free, fresh and comfortable working environment.

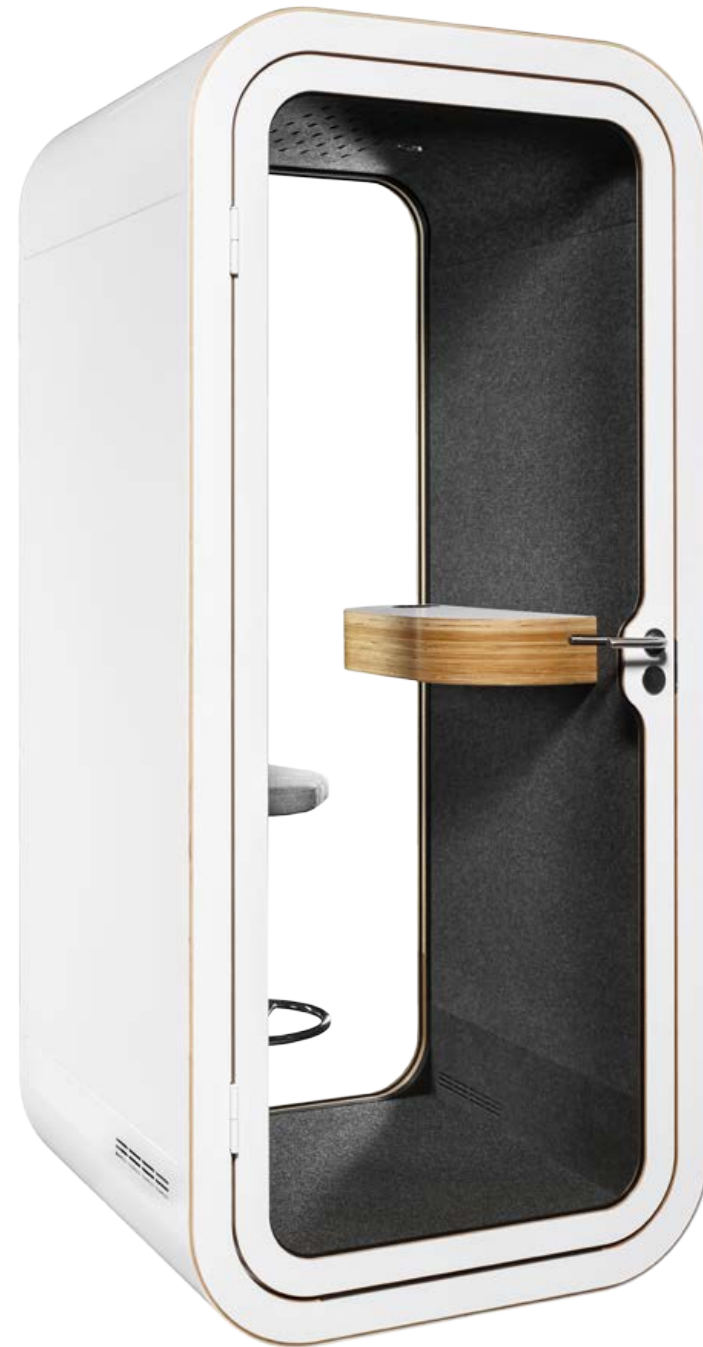

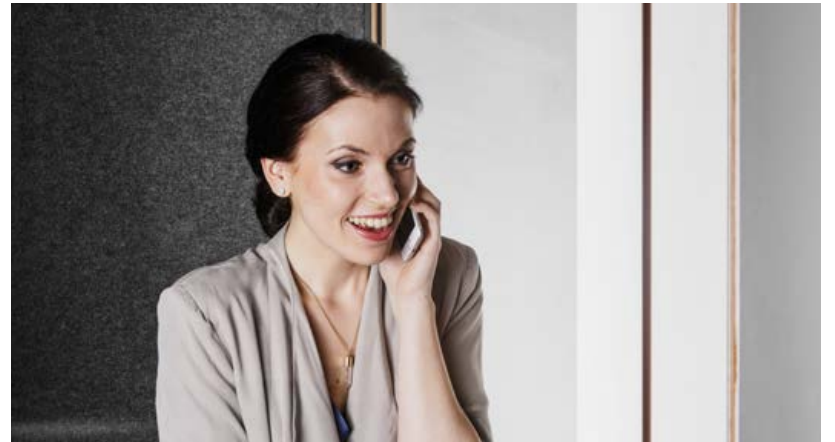

FRAMERY Q

It takes two to tango

Framery Q adds space and comfortable accessories for the use of two people, allowing them to have meetings, brainstorming sessions and important one-on-one conversations.

Just like Framery O, Framery Q has all the equipment needed for your convenience, but now for two people. This way both users can benefit from privacy and a soundproof environment at the same time. Framery Q has multiple options for its accessories and furniture, and it can be installed in any space without massive work.



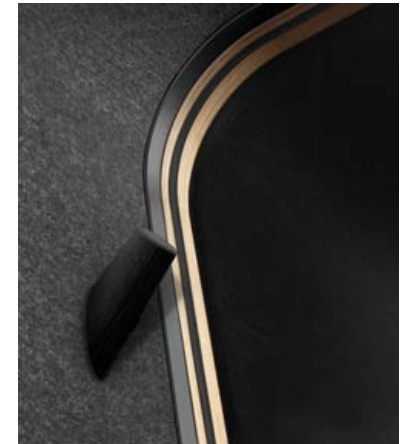

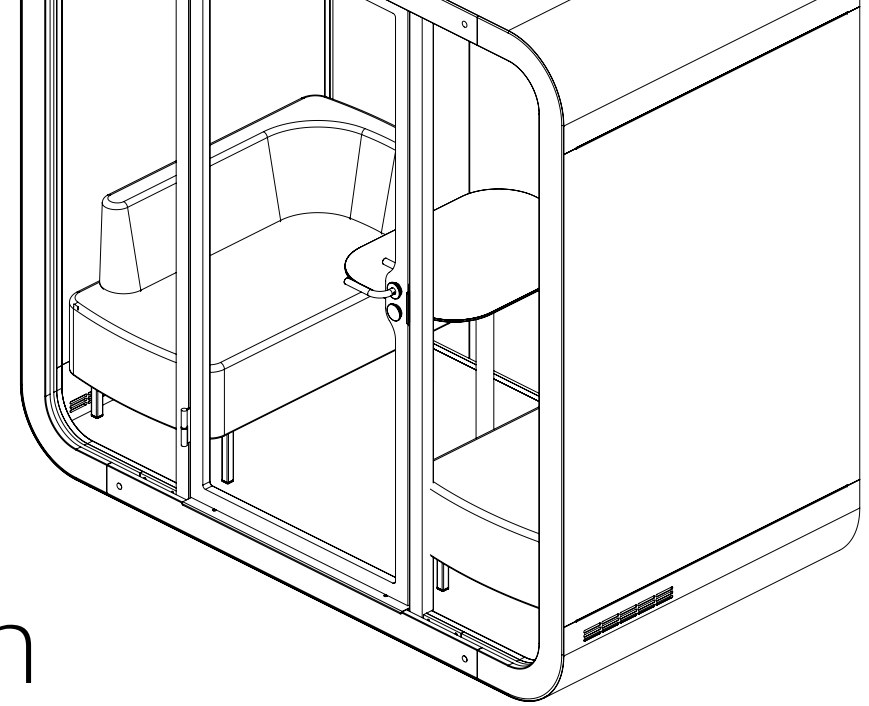

FRAMERY Q COMES IN MANY FORMS

What kind of interior design would you prefer?

Framery Q can be crafted to suit your needs in various ways from a wide range of useful accessories, fashionable colours and comfortable seat options. Choose your preferred decor and we'll provide it.

For some tasks, it is easier when both persons look the same direction – like in video conferences. Sometimes, it is better to be face to face and focused on the conversation at hand. Or you can take it easy, lay down and let your imagination flow. Maybe just having some private space

to help you focus on something really demanding. Either way, our products are versatile and designed to match your whims and needs. Here are four style examples for Framery Q. If you have something else in mind, ask us and we will do our best to help you.



Working with PAL

A high table and handy bar stools makes this decor option very efficient for short-term sessions. The shape of the desk is suitable for the teamwork of two, private sessions or video conferences. Working with PAL comes with pleasant LED lighting, two power sockets and stylish coat hangers.

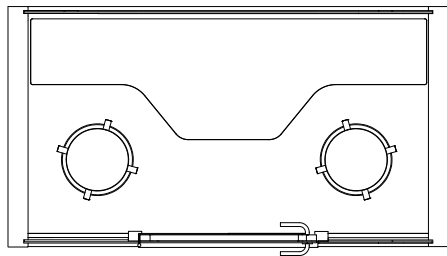

Me Time

Sometimes you need your own space to work without distractions for longer periods of time. The electric table can be adjusted into a sitting or standing position. It also works well with a wheelchair. A handy table, adjustable LED lighting and two power sockets guarantee that your time in the booth is both pleasant and productive.

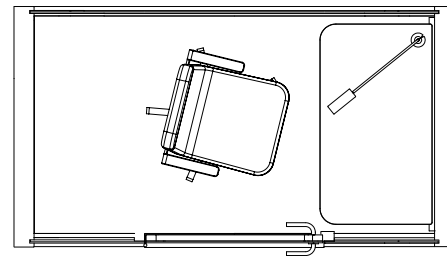

Betty's Café

Betty chairs are comfortable for brainstorming conversations and reading. A small table is the perfect addition for coffee mugs and small accessories. A special mood is created with LED lighting hanging from the ceiling. The Betty chair comes with two power sockets for loading phones, laptops and more.

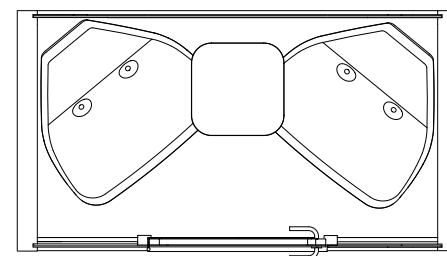

Meeting Maggie

Maggie chairs with low backs can be adjusted to many positions. This variation is suitable for meetings, brainstorming and more. The small table can be adjusted into any direction – depending on whether you need it for your coffee mug or laptop – or not. The LED lighting and two power sockets take care of your eyes and devices.

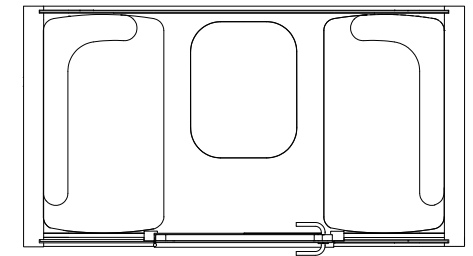

Get more with Framery

*With Framery products, you can design your office in a new and clever way.
Easy to assemble, easy to use, easy to move – Framery adapts to your office.
Turn efficiency up, and let people bloom.*

Users should be able to walk to the booth in a few seconds when their phone rings, or to have a spontaneous discussion with a colleague.

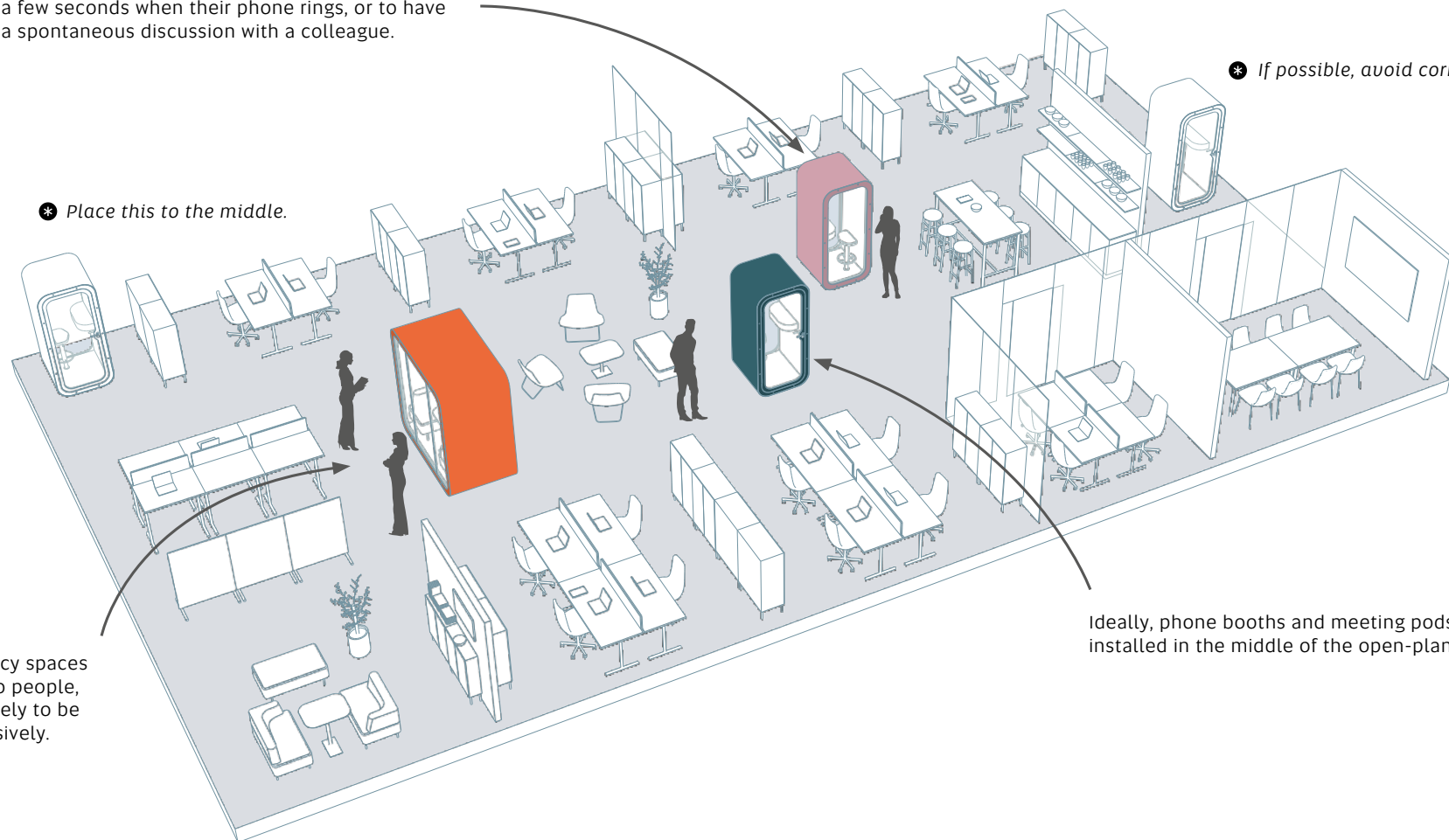

* Place this to the middle.

* If possible, avoid corridors.

When privacy spaces are close to people, they are likely to be used intensively.

Ideally, phone booths and meeting pods are installed in the middle of the open-plan office.

* If possible, do not place phone booths in corridors or lobbies. This makes them difficult to reach and may result in low utilization.



Great thoughts thrive in silence.

framery

We are global.

Find your nearest dealer:
frameryacoustics.com/dealers



Framery Oy



✉
Patamäenkatu 7
33900 Tampere
FINLAND

VAT: FI 23527139

🌐 frameryacoustics.com
f fb.com/FrameryThePhoneBoothCompany
🐦 twitter.com/frameryfinland
in LinkedIn: Framery Acoustics
📷 #framery
