

Flextable

education training hospitality meeting conference



FLEXTABLE FOLDING WORK TABLE

The Flextable provides you with the perfect starting point for a flexible working environment.

Space-saving in its 'fold-and-store' capabilities yet superbly designed. Only a single person is required to set up and rearrange the mobile folding tables – without any tools or special skills involved. Also, if used within an office environment and partitions are used to divide up rooms, the Flextable can be transformed into a large conference layout in no time.

Desk-sharing, flexible teamwork and short-term staffing integration of contractors and freelancers into specific project groups have become a ever increasing normality of our daily business routine. This needed working environment flexibility is now required to be reflected in current office furniture too. Flextable has been developed exactly for this reason to provide to market a table that can accommodate both individual persons or a group of ten.

With Flextable every environment - whether it is in education, training, hospitality, meeting or conference - allows for flexibility and maximisation of every users creativity.

FLEXTABLE
FOLDING WORK TABLE



Fixed - Working Conference position



One-person folding mechanism for ease of use



Folded - Mobile and Storage position

Conferencing

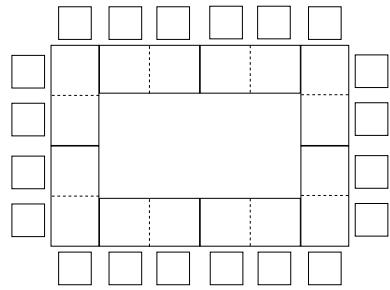

Configuration using:
8no. W2000 x D800mm (FLEX-S-2026)

Presentation

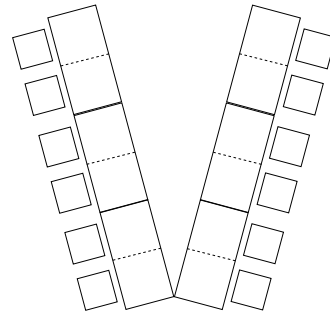

Configuration using:
6no. W2000 x D800mm (FLEX-S-2026)

Teaching

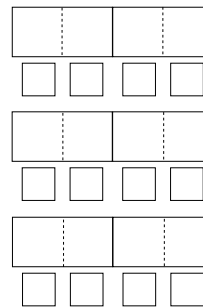

Configuration using:
6no. W2000 x D800mm (FLEX-S-2026)

Events

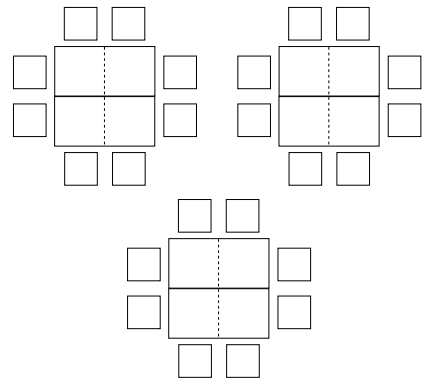

Configuration using:
6no. W2000 x D800mm (FLEX-S-2026)

Seminar / Training

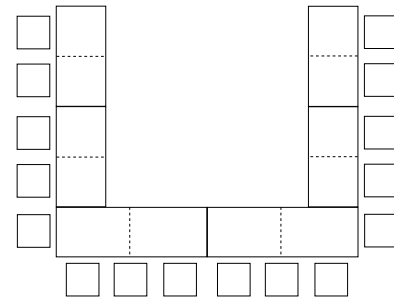

Configuration using:
4no. W2000 x D800mm (FLEX-S-2026)
2no. W2800 x D800mm (FLEX-L-2832)

Meeting

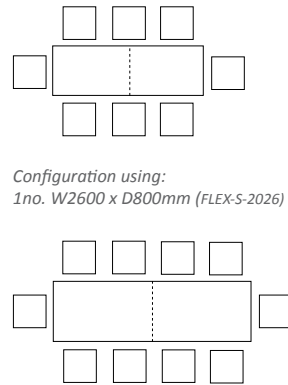

Configuration using:
1no. W3200 x D1050mm (FLEX-L-2832)

Meeting

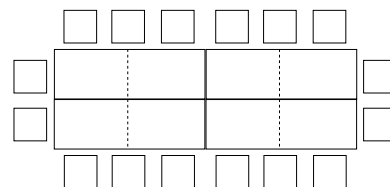

Configuration using:
4no. W2800 x D800mm (FLEX-L-2832)

Boardroom

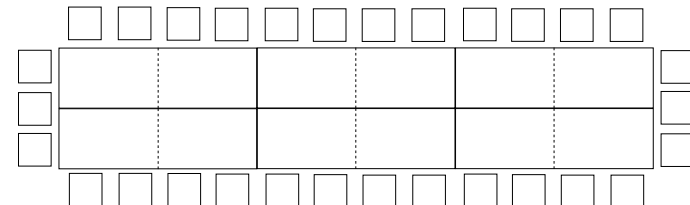

Configuration using:
6no. W3200 x D1050mm (FLEX-L-2832)

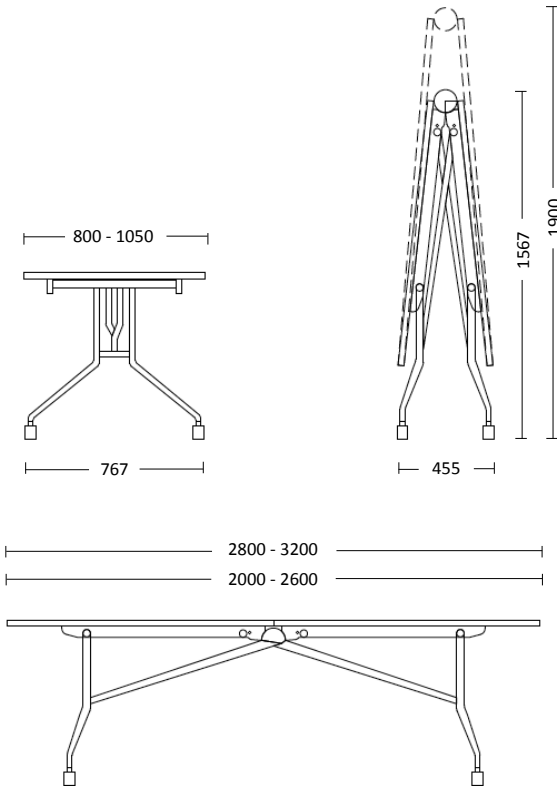

FLEXTABLE
TABLE SPECIFICATIONS

Flextable is a folding conference table that combines the usability of a large scale meeting table with the functionality of a folding table. This flexibility allows the user to create a multi-functional environment out of any meeting or conference room.

The Flextable folding conference table is available in 2 length variations of:

*W2000-2600 x D800-1050mm
W2800-3200 x D800-1050mm*

The frame uses a simple light touch one-person folding mechanism (once underside table top latches are unlocked) for ease of use.



Anti-shock system avoids squeezing fingers when folding tops.



Duo-tone castor with brake



Underside table top latch-lock



FLEXTABLE
FOLDING WORK TABLE

*Large Table FLEX-L-2832
(W3200 x D1050mm shown)*



*Small Table FLEX-S-2026
(W2600 x D800mm shown)*



FURNITURE IS ARCHITECTURE ON A DIFFERENT SCALE



www.xchangedesign.com