Migration SE Pro

Statement of Line	2
--------------------------	----------

Product Details	
Migration SE Pro Desk	8
Migration SE Pro Bench	12
Migration SE Pro Meeting Table	15
Base	18
Worksurface	19
Screen	20
Cable Management	22

Specifying	
Worksurface	27
Base	37
Screens	55
Cable Management	60

Surface Materials	69
--------------------------	-----------

Migration SE Pro Desk

Statement of Line

Desk Worksurface

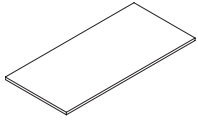

Specifying
▶ Page 27

Linear Worksurface for Desk

	1200W	1400W	1500W	1600W	1800W
700D					
750D					
800D					
900D					

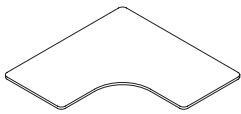

Specifying
▶ Page 29

90° Worksurface for Desk

	1400W	1600W	1800W
700D	•	•	•
750D	•	•	•
800D		•	•

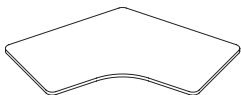

Specifying
▶ Page 31

120° Worksurface for Desk

	1200W	1400W	1600W
700D	•	•	•
750D	•	•	•
800D	•	•	•

Base for Desk

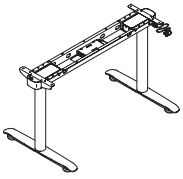

Linear base for desk

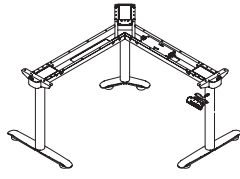

90° base for desk

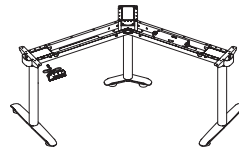

120° base for desk

Migration SE Pro Bench

Statement of Line

Bench Worksurface

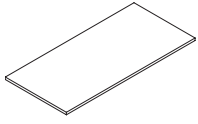

Specifying
▶ Page 27

Linear Worksurface for Single Sided Bench

	1200W	1400W	1500W	1600W	1800W
700D					
750D					
800D					
900D					

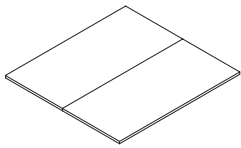

Specifying
▶ Page 27

Linear Worksurface for Dual Sided Bench

	1200W	1400W	1500W	1600W	1800W
1400D					
1500D					
1600D					
1800D					

Bench Worksurface, continued



Focus worksurface

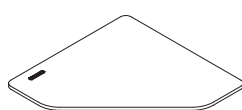

Team worksurface

Specifying
▶ Page 34

90° Worksurface for Bench

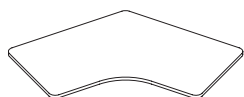

Specifying
▶ Page 31

120° Worksurface for Bench – 2-Leg

	1000W	1200W
700D	•	•
750D	•	•
800D		•



Specifying
▶ Page 31

120° Worksurface for Bench – 3-Leg

	1400W	1600W
700D	•	•
750D	•	•
800D	•	•

Base for Bench

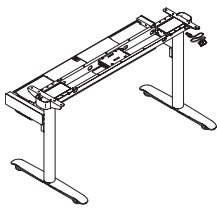

Linear Bench - Single-Sided

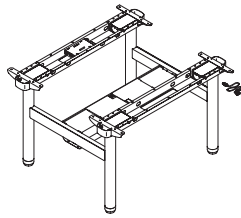

Linear Bench - Dual-Sided

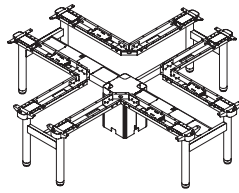

90° Bench

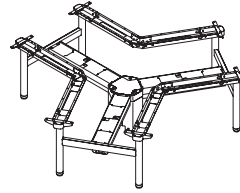

120° Bench - 2-Leg

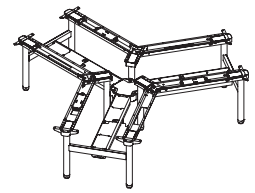

120° Bench - 3-Leg

Cable Management Accessories

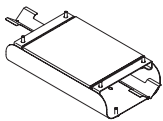

Connector for Cable Trough - Bench

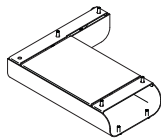

Connector for Cable Trough - Egress

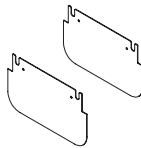

End Covers for Cable Trough

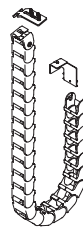

Cable Chain - Cable Trough to Upper Tray L1200



Cable Chain - Floor Infeed L570

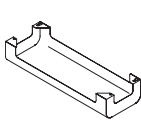

Simple

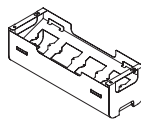

Metal

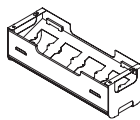

Metal-PET

Upper Cable Tray

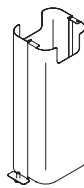

Vertical Riser

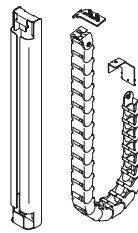

Cable Chain for Desk

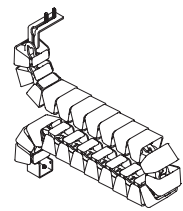

High Capacity Cable Chain

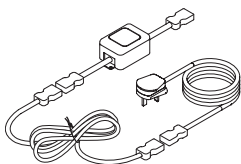

AH Meyer Netbox M1 Package

Migration SE Pro Meeting Table

Statement of Line

Meeting Table Worksurface

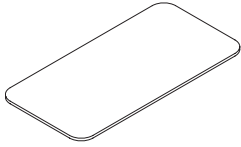

Specifying
▶ Page 36

Rectangular Worksurface

	1800W	2200W
900D	•	•

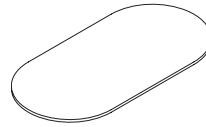

Specifying
▶ Page 36

Pill Worksurface

	1800W	2200W
900D	•	•

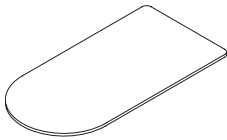

Specifying
▶ Page 36

Flat Edge Worksurface

	1800W	2200W
900D	•	•

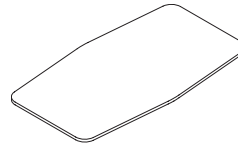

Specifying
▶ Page 36

Hexagon Worksurface

	1800W	2200W
800–1000D*	•	•

*Hexagon worksurface max depth at center is 1000D, at either end is 800D.

Base for Meeting Table

Specifying
▶ Page 53

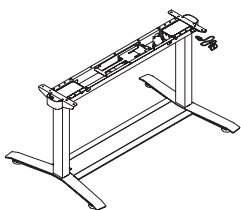

Migration SE Pro Desk

Migration SE Pro Desk

supports well-being at work by allowing users to move between seated and standing postured throughout their workday.

Desk has a wood core with a Low-Pressure Laminate surface and 25mm thick with both straight and radius corner.

Height-adjustable base adjusts from 720–1180mm (basic), 650–1250 mm (extended) and 720 mm (fixed height).

Push buttons up/down and pre-sets controller adjusts height at the rate 30mm per second (basic) and 38mm per second (extended). All SE Pro Desks come with default Gyroscope Sensor.

Base supports a maximum distributed weight load of 125kg.

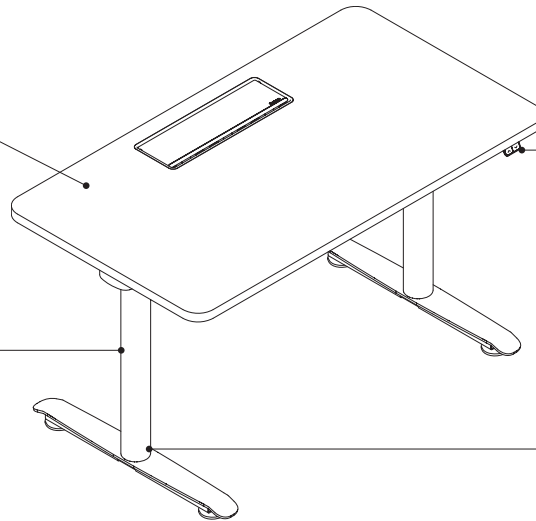

Internal motors with electronic synchronization.

Leveling glides adjust 25mm to install desk on uneven floors.

Worktop integrated controller keeps adjustment within easy reach of the user. Up/down and Preset controller options available for selection.

Middle leg with an expanded footprint provides higher rigidity and stability performance.

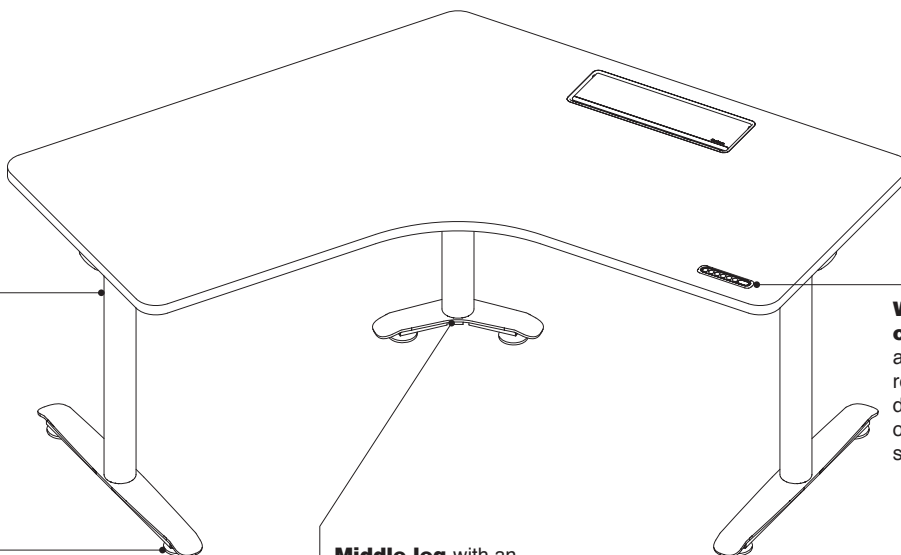

Product Details

Low-Pressure Laminate Desks

Front (user's) edge profile is available in a straight edge or 30° chamfered edge profile.

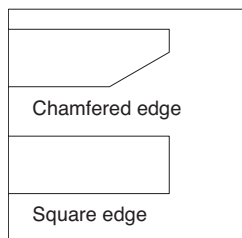

Chamfered edge for workstations is applied on 3 edges (except for the back edge), for meeting table is applied on 4 edges.

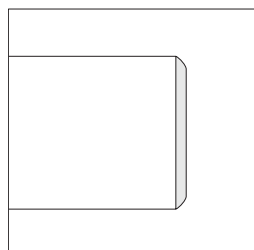

Edge profile finishes are specified separately from laminate color.

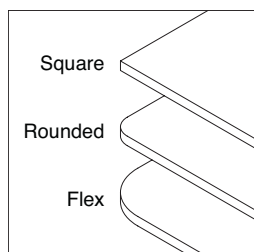

Square and rounded corners are standard. Square corners have 90° Flex corners for Flex curved screen application is available on linear worktops. corners on all four sides.

Migration SE Pro Desks adjust 650 – 1250 mm (extended range) and 720 – 1180mm (basic range), with +/-5mm tolerance.

Tip: Specify basic range option to fit a UPV pedestal or SOTO caddy underneath the Migration SE Pro Desk without risk of collision.

The basic range provides 587mm of clearance under the desk structure, while the extended range provides 517mm of clearance under the desk structure.

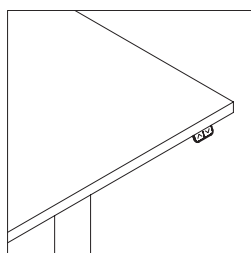

Up/down controller is standard and easily adjusts height of desk by simply pushing the up and down arrows at the rate of 30 mm per second (basic) and 38 mm per second (extended).

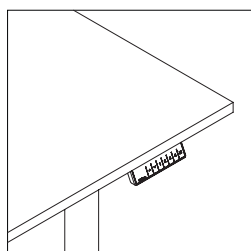

4 pre-set programmable controller is available as an option. It allows users to set the seated and standing height positions or pre-set heights for multiple users. When activated, the digital display will show the height of desk. Height shown on the controller display assumes a 25mm top.

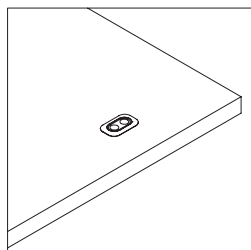

Simple Integrated controller is available as an option. It allows users to adjust the height of the desk without reaching under the worktop

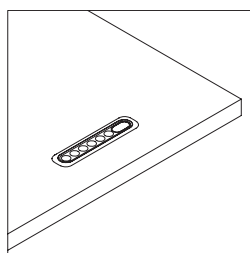

3 pre-set integrated controller is available as an option. Users can save up to 3 pre-set heights for quick adjustment. When activated, the digital display will show the height of desk. Height shown on the controller display assumes a 25mm top.

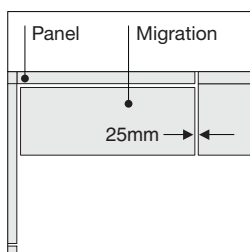

Listed worksurface sizes are for planning purposes and have a 25mm gap built in to account for pinch points.

Electric motor with whisper quiet operation adjusts at 30 mm per second (basic) and 38 mm per second (extended). Motor is 24V DC and includes a 3 meter power cord. Motor also has 0.1W standby power.

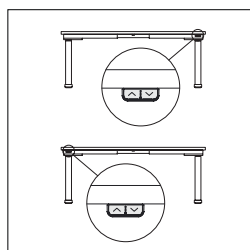

Controller can be mounted on either the left or right-hand side of the top and is field installed.

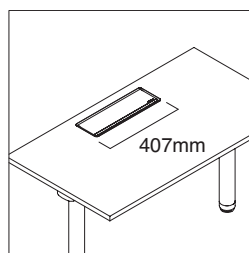

Power doors allow for easy user access into cable tray. They are available on worksurfaces as an upcharge, with an option of two paint colors.

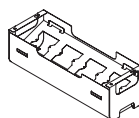

Cable tray provides housing for power and data ports, and can be hard-wired or soft-wired.

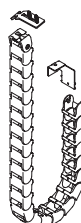

Cable chain only available in Merle.

Surface Materials

Low-Pressure Laminate Desks

- Laminate
- ▶ See *Surface Materials*, page 69

2mm Edge Profile

- Plastic

Height-adjustable base

- Paint
- ▶ See *Surface Materials*, page 69

Application Topics

Moving desks can collide with other components. Do not install overhead storage, desk-height power, or desk accessories in the path of height-adjustable desks.

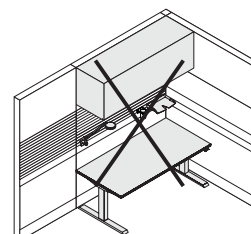

Cableways mount to desks to help manage cables at desk height for a clean aesthetic and can be used in combination with screens.

Worksurfaces ship with pre-drilled holes for mounting bases.

Height-adjustable base requires attachment to the desk.

Desk Weight

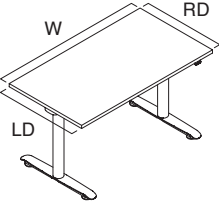
	W	LD	RD	Worksurface Weight	
	Rectangular — 700D	1200	700	700	11.57 kg
		1400	700	700	13.58 kg
		1500	700	700	14.58 kg
		1600	700	700	15.59 kg
		1800	700	700	17.60 kg
Rectangular — 750D	1200	750	750	12.42 kg	
	1400	750	750	14.58 kg	
	1500	750	750	15.66 kg	
	1600	750	750	16.74 kg	
	1800	750	750	18.90 kg	
Rectangular — 800D	1200	800	800	13.28 kg	
	1400	800	800	15.59 kg	
	1500	800	800	16.74 kg	
	1600	800	800	17.90 kg	
	1800	800	800	20.21 kg	
Rectangular — 900D	1200	900	900	14.99 kg	
	1400	900	900	17.6 kg	
	1500	900	900	18.9 kg	
	1600	900	900	20.21 kg	
	1800	900	900	22.82 kg	

Product Specification

Desk

Product Specification

Range of Adjustment (with +/-5mm tolerance)	Basic : 720 - 1180 mm Extended : 650 - 1250 mm Fixed : 720 mm
Glide Adjustment	25 mm
Distributed Weight Capacity (does not include worksurface weight)	125 kg
Wire Management Included	Yes
Controller	Up//Down and 4-preset
Decibel Rating	< 50 dB
Volts	100V AC (Japan) 110V AC (Taiwan) 240v AC (Global)
Frequency & Phase	60Hz, Single-Phase (North America) 50Hz, Single-Phase (Global) 50-60Hz, Single-Phase (Japan)
Amps	5.0A
Watts	400W (2-Leg) 500W (3-Leg)
Standby Power	0.1W
Adjustability Speed	30 mm/sec (Basic) 38 mm/sec (Extended)
Duty Cycle	10%

Linear Bench

: **The bench** configuration for Migration SE Pro Bench consists of 4 components:

- : 1. Base
- : 2. Worksurface
- : 3. Cable trough
- : 4. Screen

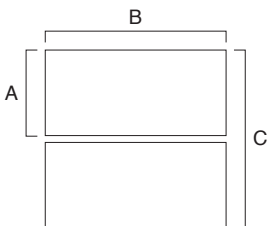
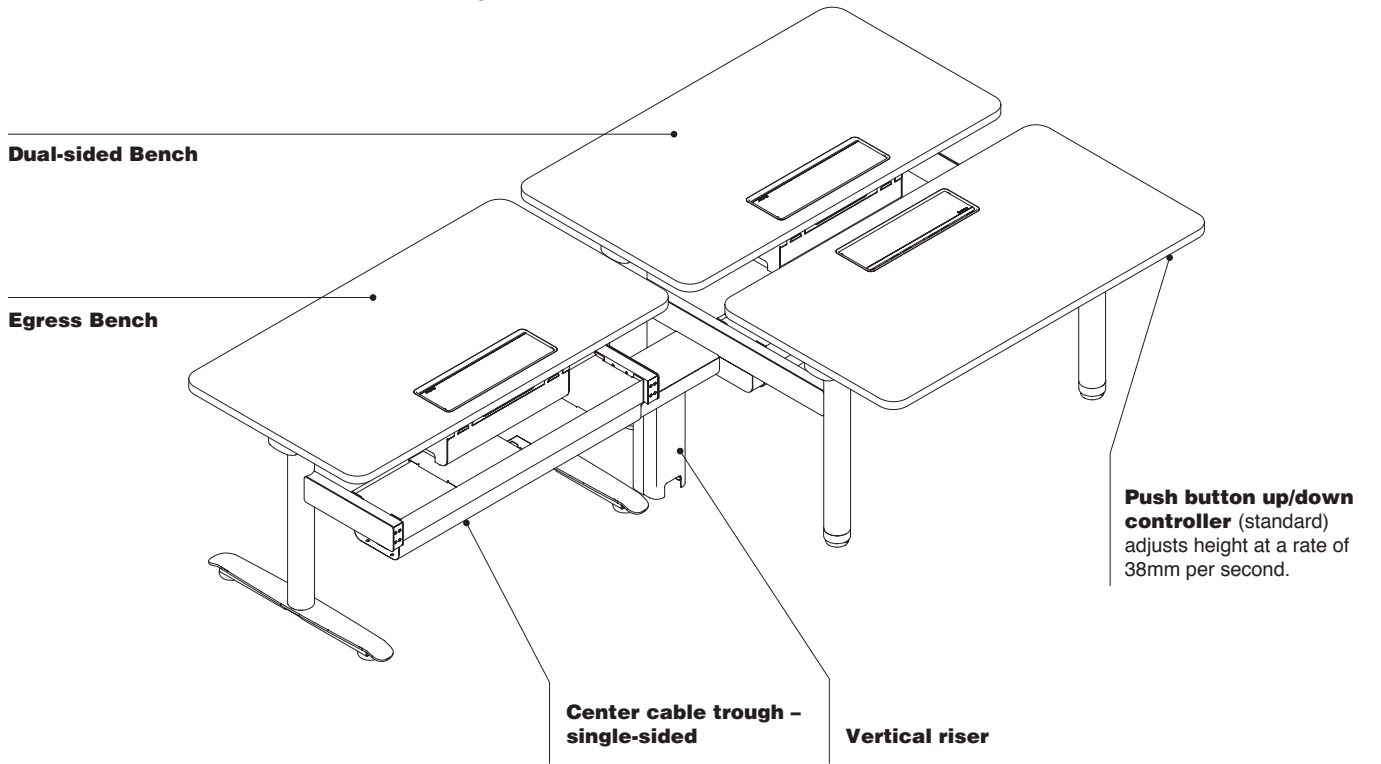
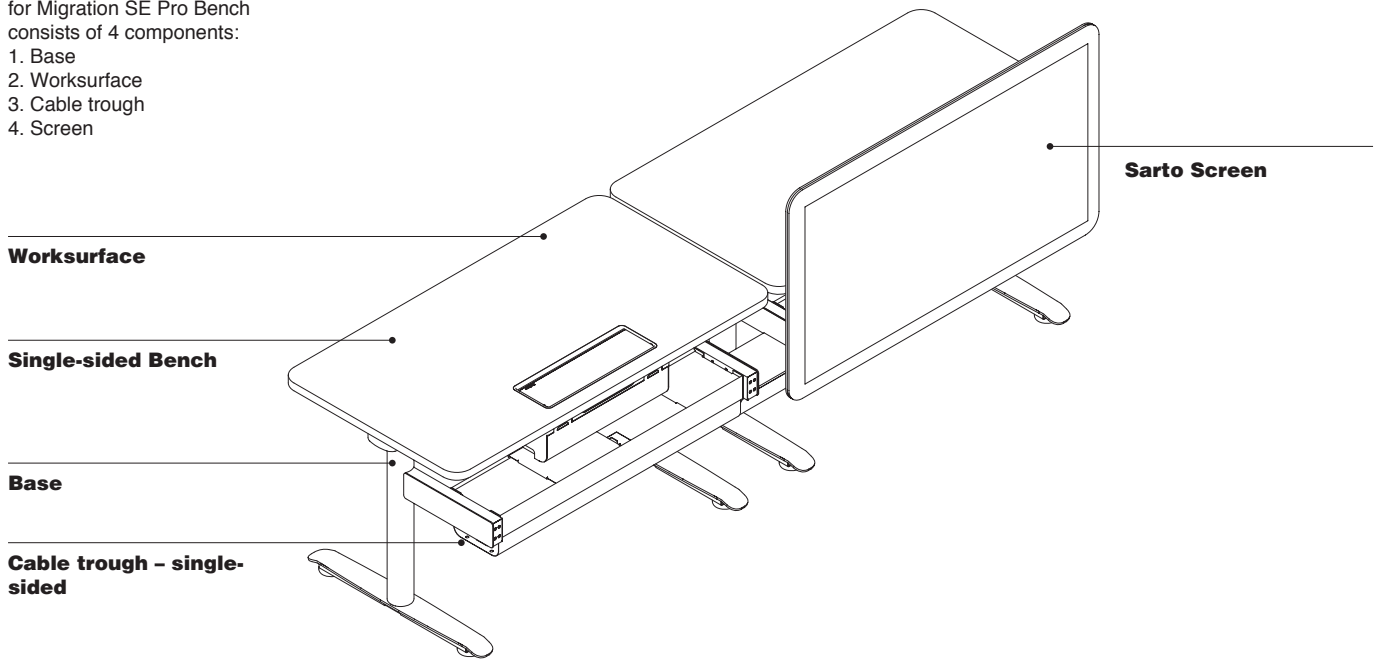

Actual Dimension (mm)

A	650, 700, 750, 850
B	1175, 1375, 1475, 1575, 1775
C	1400, 1500, 1600, 1800

90° Bench

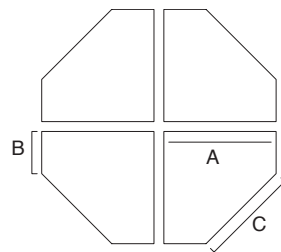
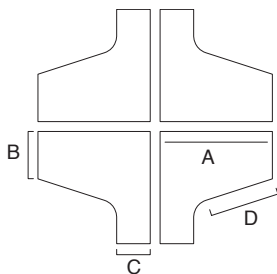
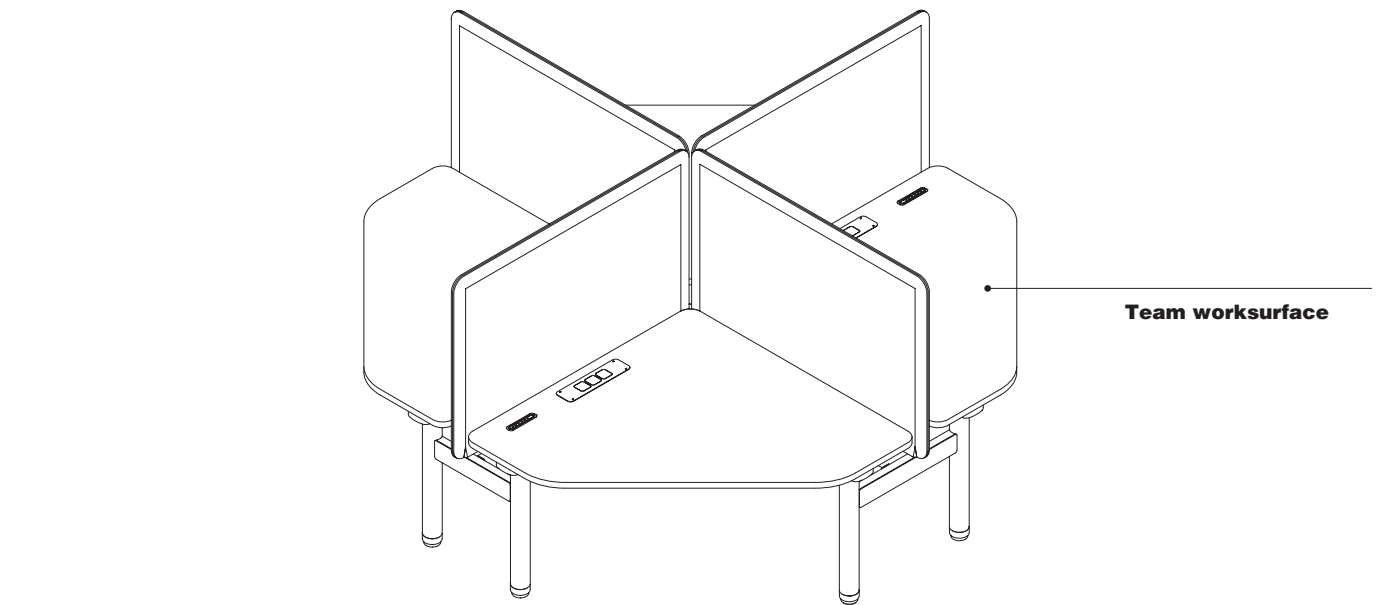
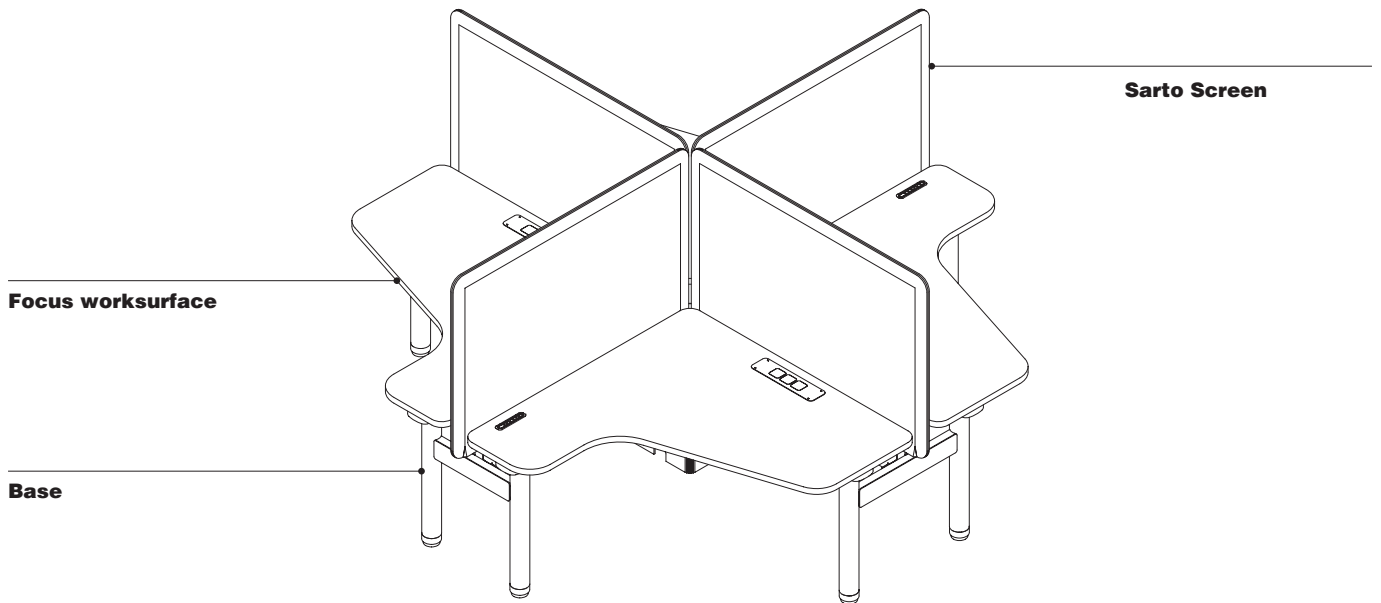

Actual Dimension (mm)

	Focus worksurface	Team worksurface
A	1138	1138
B	480	394
C	340	1052
D	838	

120° Bench

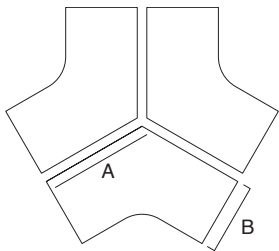
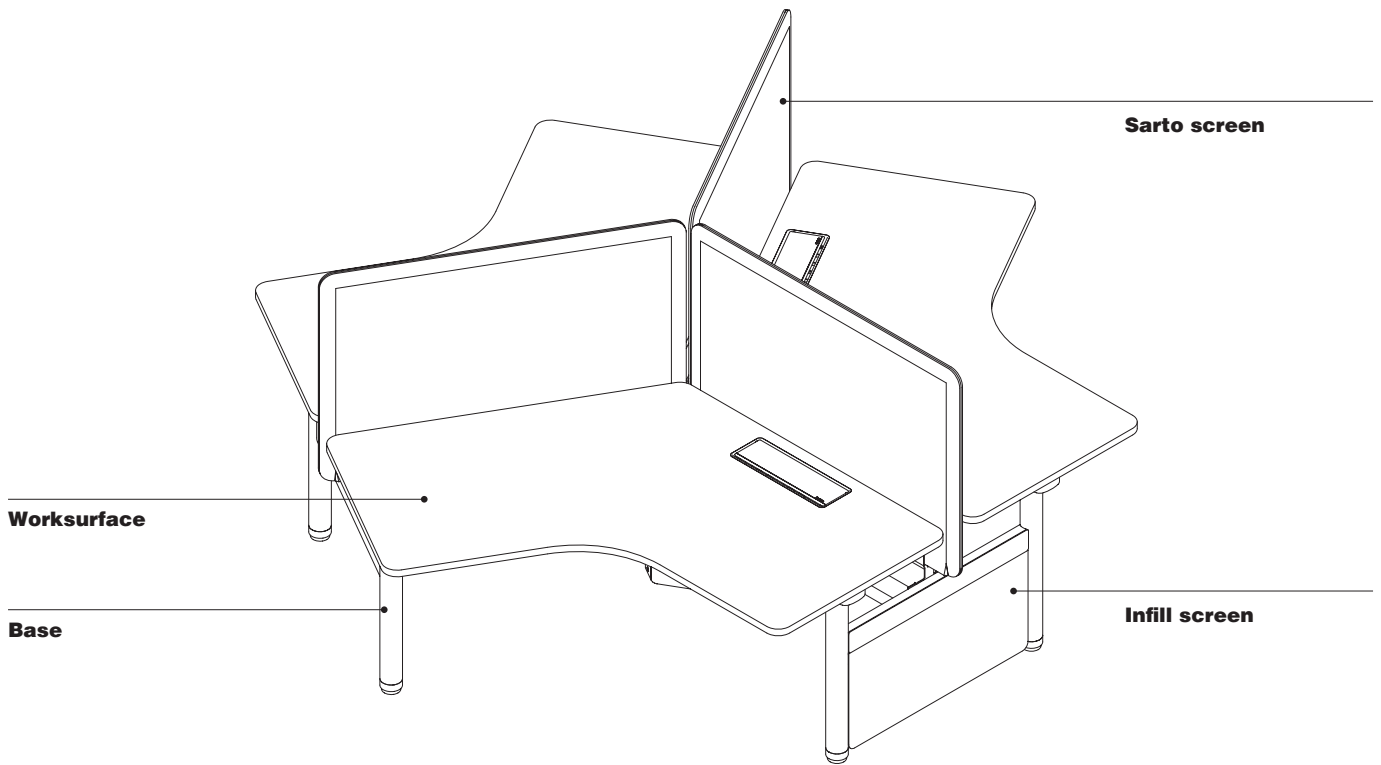

Actual Dimension (mm)

A	959, 1159, 1359, 1559
B	650, 700, 750

Note: 959 X 750 worksurface is not available

Migration SE Pro Meeting Table

Migration SE Pro Meeting Table supports well-being by allowing teams to adjust between seating or standing mode in throughout their collaborative sessions.

Meeting table work-surface with straight edge has a wood core with a Low-Pressure Laminate surface and 25mm thick with both straight and radius corner. Chamfered edge worksurface option available with LPL surface and MDF core.

Meeting table work-surface top shape comes in four options: rectangular, pill, flat edge and hexagon.

Internal motors with electronic synchronization.

Height-adjustable base adjusts from 720–1180mm (basic), 650–1250 mm (extended).

Leveling glides adjust 25mm to install meeting table on uneven floors.

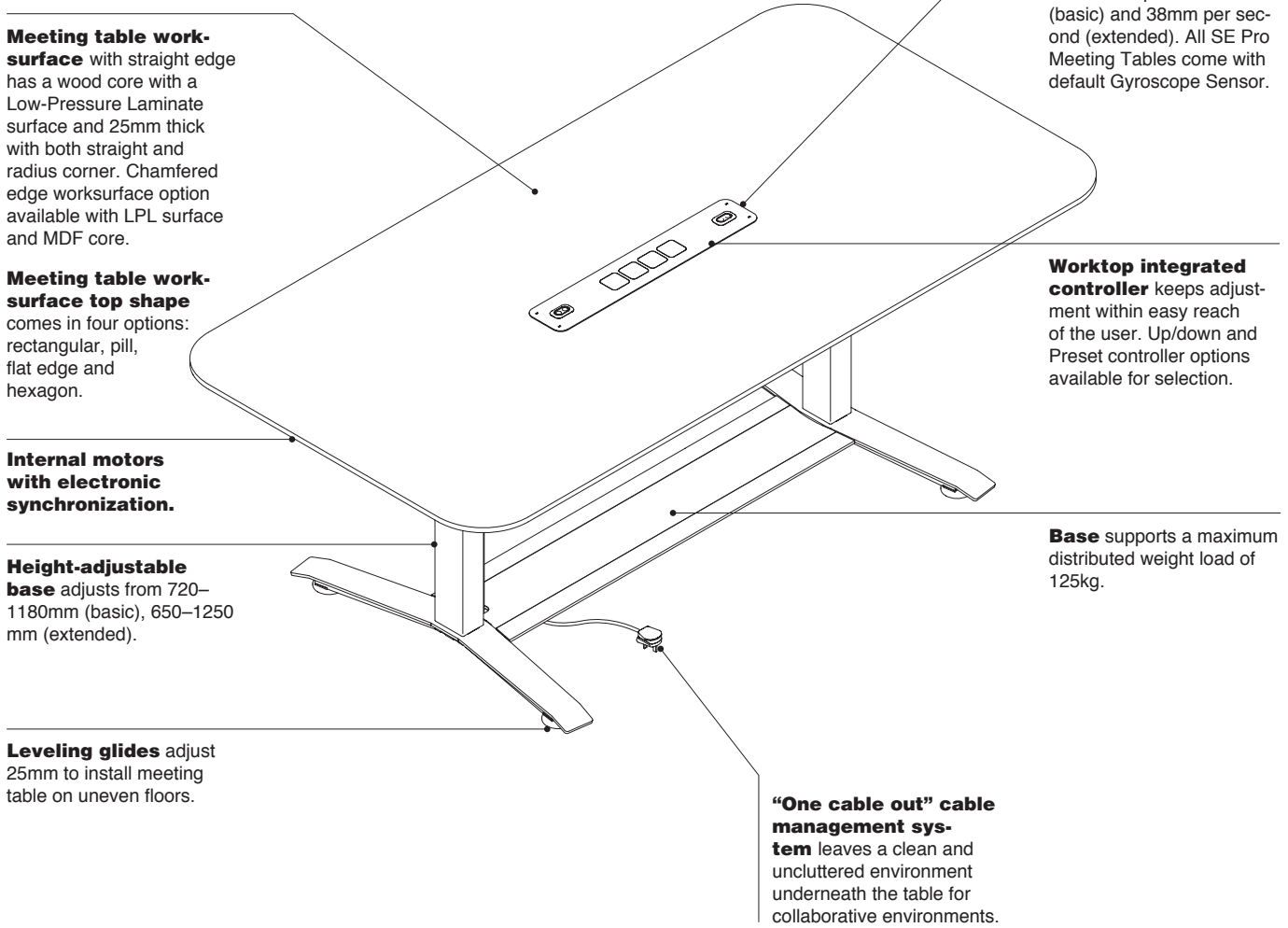

Push buttons up/down and pre-sets controller adjusts height at the rate 30mm per second (basic) and 38mm per second (extended). All SE Pro Meeting Tables come with default Gyroscope Sensor.

Worktop integrated controller keeps adjustment within easy reach of the user. Up/down and Preset controller options available for selection.

Base supports a maximum distributed weight load of 125kg.

“One cable out” cable management system leaves a clean and uncluttered environment underneath the table for collaborative environments.

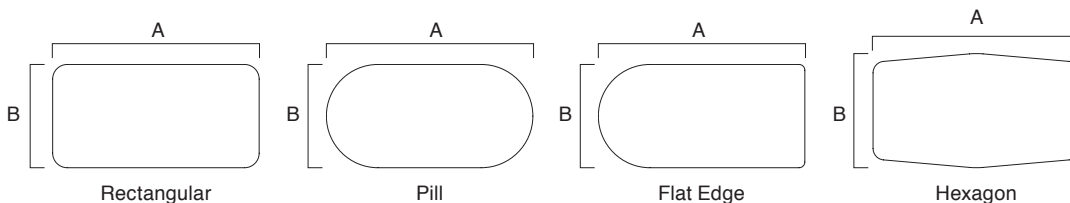

Actual Dimension (mm)

A	1800, 2200
B	900, 800–1000 (Hexagon)

Product Details

Low-Pressure Laminate Tops

Low-pressure laminate tops edge profile is available in a straight edge or 15° chamfered edge profile.

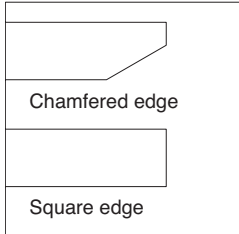

Chamfered edge is applied on all sides of the worksurface.

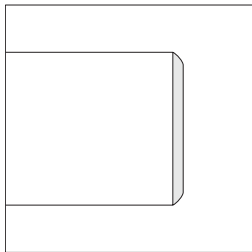

Edge profile finishes are specified separately from laminate color.

Migration SE Pro Meeting Table adjusts 650 – 1250 mm (extended range) and 720 – 1180mm (basic range), with +/-5mm tolerance.

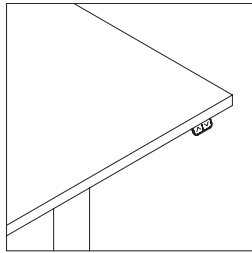

Up/down controller is standard and easily adjusts height of table by simply pushing the up and down arrows at the rate of 30 mm per second (basic) and 38 mm per second (extended).

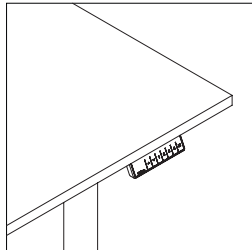

Double Simple Integrated controller configuration is available as an option to allow table height controls to be within reach of all users around the meeting table. In the case when up and down are pressed simultaneously on both controllers, downward instruction will prevail.

4 pre-set programmable controller is available as an option. It allows users to set the seated and standing height positions or pre-set heights for multiple users. When activated, the digital display will show the height of table. Height shown on the controller display assumes a 25mm top.

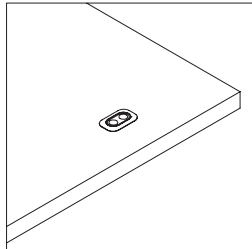

Simple Integrated controller is available as an option. It allows users to adjust the height of the table without reaching under the worktop

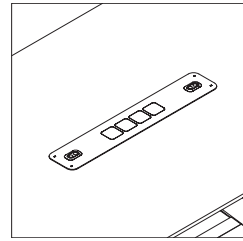

3 pre-set integrated controller is available as an option. Users can save up to 3 pre-set heights for quick adjustment. When activated, the digital display will show the height of table. Height shown on the controller display assumes a 25mm top.

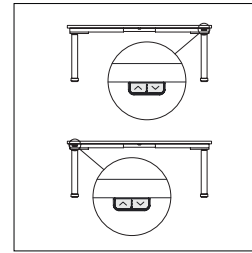
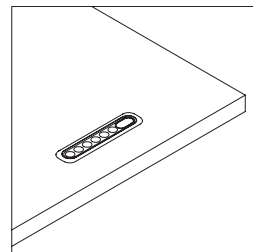

Controller can be mounted on either the left or right-hand side of the top and is field installed.

Power doors allow for easy user access into cable tray. They are available on worksurfaces as an upcharge, with an option of two paint colors.

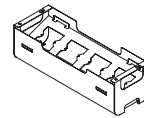

Cable management system allows one cable out solution for height adjustable base and table top power.

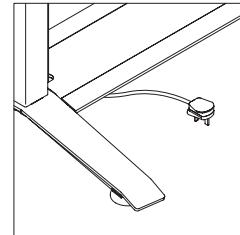

One cable out cable management system requires AH Meyer M1 package to be specified with the meeting table base.

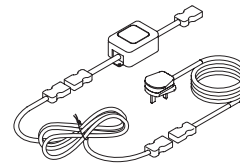

Listed worksurface sizes are for planning purposes and have a 25mm gap built in to account for pinch points.

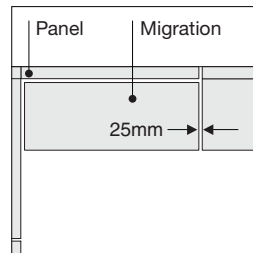

Listed worksurface sizes are for planning purposes and have a 25mm gap built in to account for pinch points.

Electric motor with whisper quiet operation adjusts at 30 mm per second (basic) and 38 mm per second (extended). Motor is 24V DC and includes a 3 meter power cord. Motor also has 0.1W standby power.

Surface Materials

Low-Pressure Laminate Top

- Laminate
- ▶ See *Surface Materials*, page 69

2mm Edge Profile

- Plastic
- Paint

▶ See *Surface Materials*, page 69

Application Topics

Moving tables

can collide with other components. Do not install overhead storage, table-height power, or table accessories in the path of height-adjustable tables.

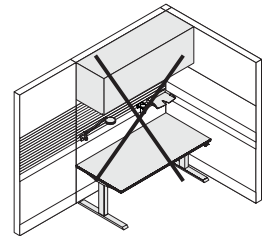

Worksurfaces ship with pre-drilled holes for mounting bases.

Height-adjustable base requires attachment to the table.

Important: Meeting table base must be specified together with AH Meyer Netbox M1 package to complete the system.

Product Specification

Meeting Table

Product Specification

Range of Adjustment (with +/-5mm tolerance)	Basic : 720 - 1180 mm Extended : 650 - 1250 mm
Glide Adjustment	25 mm
Distributed Weight Capacity (does not include worksurface weight)	125 kg
Wire Management Included	Yes
Controller	Up/Down, 4-Preset, Simple Integrated, and 3-preset Integrated
Decibel Rating	< 50 dB
Volts	100V AC (Japan) 110V AC (Taiwan) 240v AC (Global)
Frequency & Phase	60Hz, Single-Phase (North America) 50Hz, Single-Phase (Global) 50-60Hz, Single-Phase (Japan)
Amps	5.0A
Watts	400W (2-Leg)
Standby Power	0.1W
Adjustability Speed	30 mm/sec (Basic) 38 mm/sec (Extended)
Duty Cycle	10%

Base

• **Base** is available in separate style number.
 • The base style number is including power cords, control box, user controller and cable trough.

Single-sided base

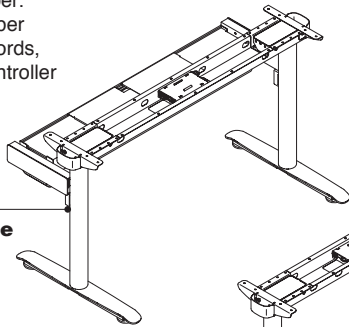

• **Lifting column** is a controlled by central control box for synchronization.
 • Columns are precision balanced to minimize surface vibrations.

• **Base** is available in fixed height, basic range and extended range of height adjustment.

90° bench base

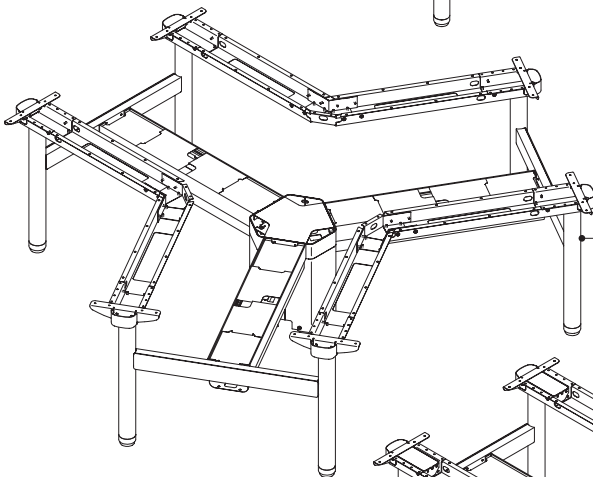

120° 3-leg bench base

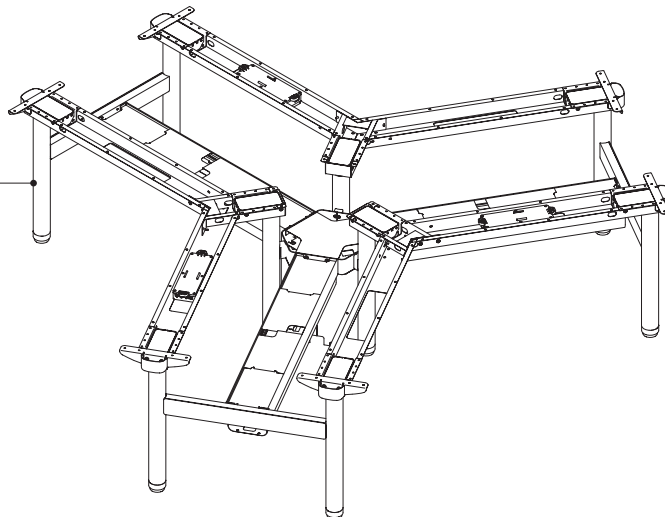

Dual-sided base

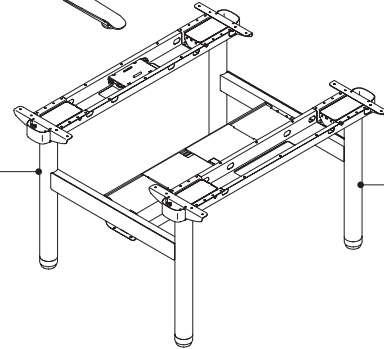

120° 2-leg bench base

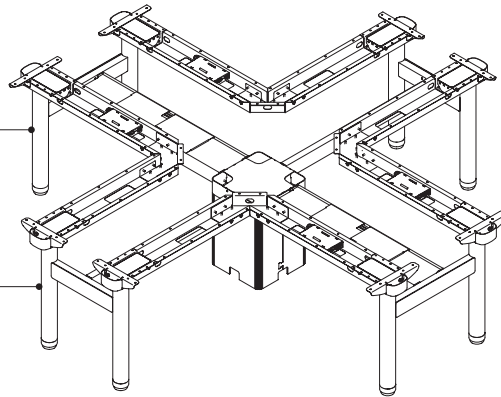

Product Details

650-1250 (mm)

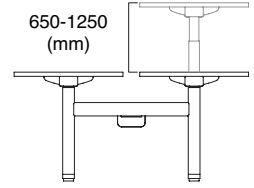

Extended range

720-1180 (mm)

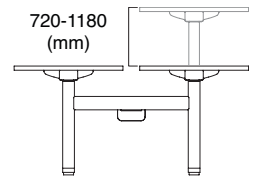

Basic range

Height adjustable range adjusts between 650 (+5/-5) – 1250 (+5/-5) mm (extended range) and 720 (+5/-5) – 1180 (+5/-5) mm (basic range).

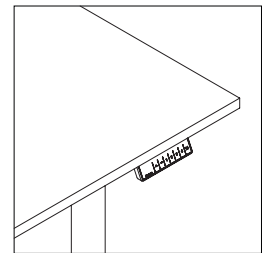

4 preset programmable controller is available as an option. It allows users to set the seated and standing height positions of pre-set heights for multiple users. When activated, the digital display will show the height of desk. Height shown on the controller display assumes a 25mm top.

Worksurface

Worksurface is an E0 board, covered by low pressure laminate finish. Ordered as a separate style number.

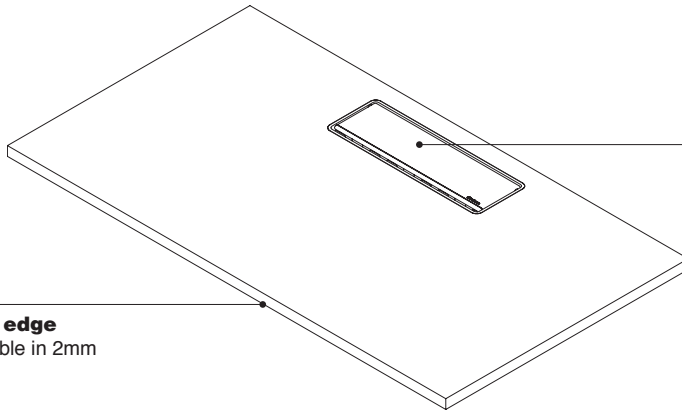

Power access doors allow for easy user access into the upper tray.

Front (user's) edge profile is available in 2mm edge profile.

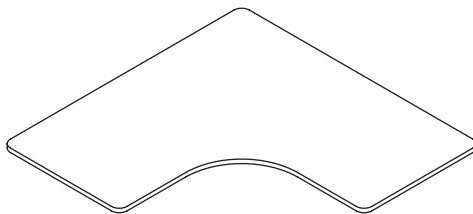

Worksurface for 90° desk

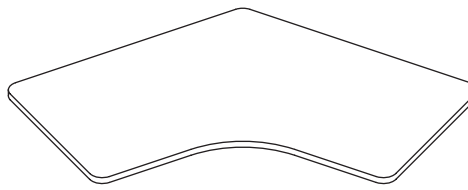

Worksurface for 120° desk and bench

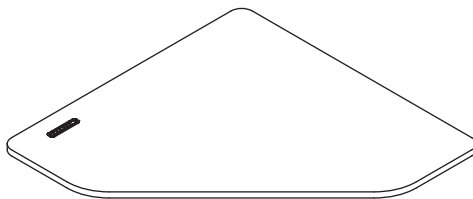

Team worksurface for 90° bench

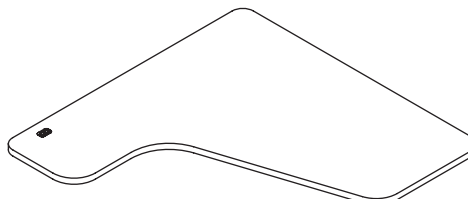

Focus worksurface for 90° bench

Chamfered edge for workstations is applied on 3 edges (except for the back edge), for meeting table is applied on 4 edges.

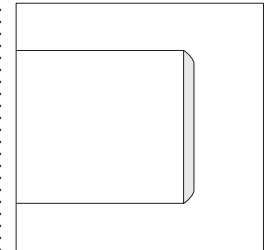

Edge profile finishes are specified separately from laminate color.

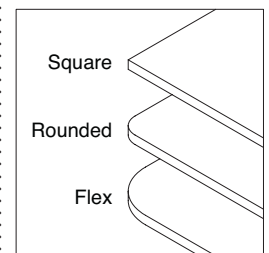

Square and rounded corners are standard. Flex corners for Flex curved screen application is available on linear worktops. Square corners have 90° corners on all four sides.

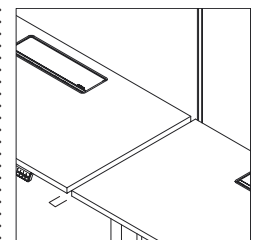
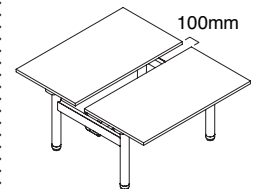

25mm gap between side-to-side worksurfaces provides pinch point clearance.

Product Details

Low-Pressure Laminate Desks

Front (user's) edge profile is available in a straight edge or 30° chamfered edge profile.

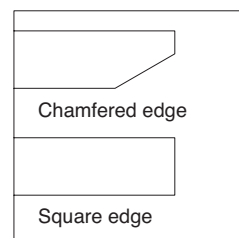

Screen

Hanging screen

provides a boundary element along the bench.

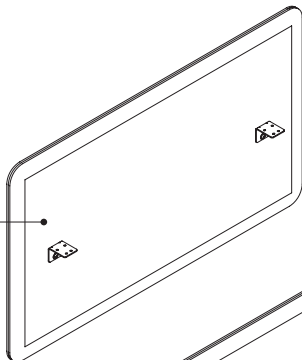

Sarto hanging screen

overall height is 665mm or 865mm. For desk application only.

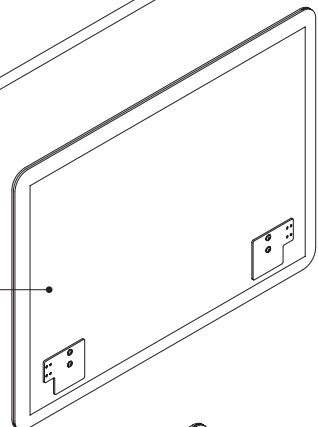

Sarto fixed screen for single-sided bench

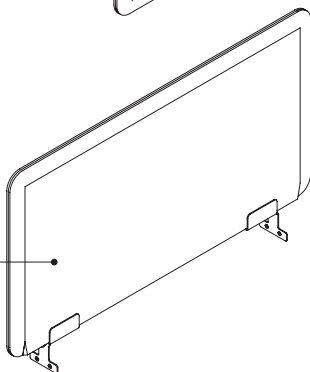

Sarto fixed center screen for dual-sided bench available in 1140mm, 1220mm or 1300mm.

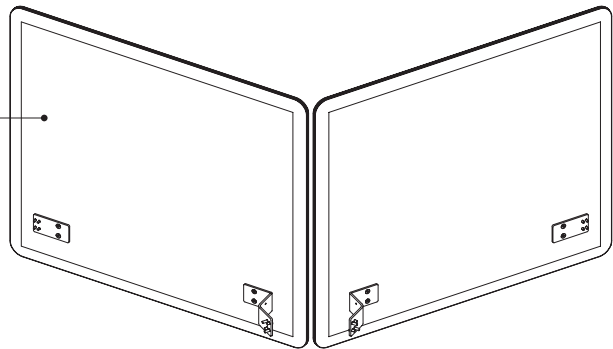

Egress front Sarto screen available in 1140mm, 1220mm, and 1300mm. For 120° bench egress application only.

Product Details

300mm
or
500mm

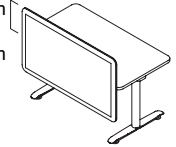

The screen height above the work surface is 300mm or 500mm.

665mm
or
865mm

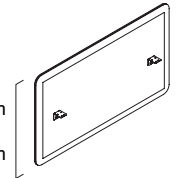

The overall height of the hanging screen is 665mm or 865mm.

Overall datum for Migration SE Pro bench center screens: 1140mm, 1220mm, 1300mm (with +/-5mm tolerance).

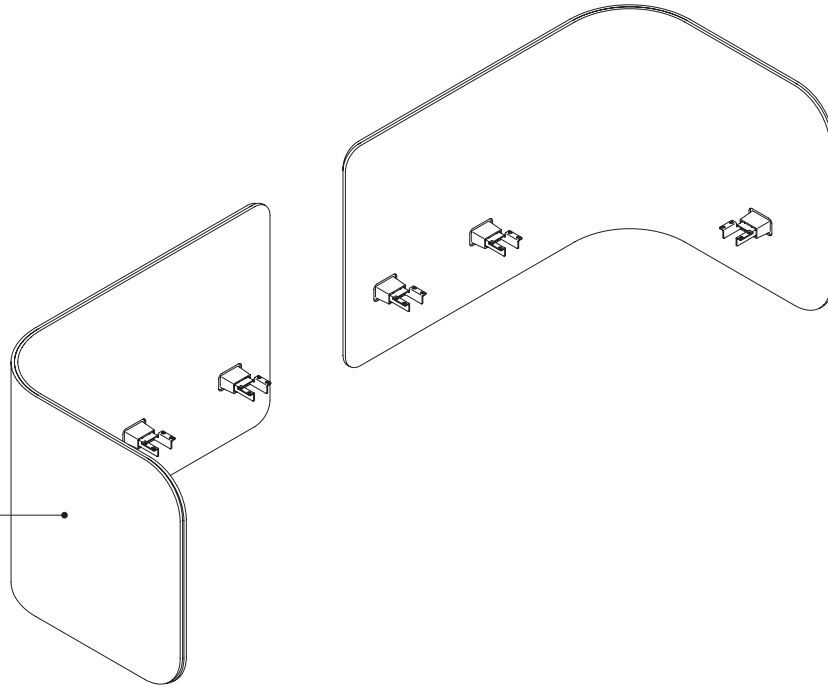

Flex curved screens can be applied on linear worktops specified with Flex corner profile. Default brackets for this application are fixed, for magnetic connection please see *Steelcase Flex Collection* specification guide.

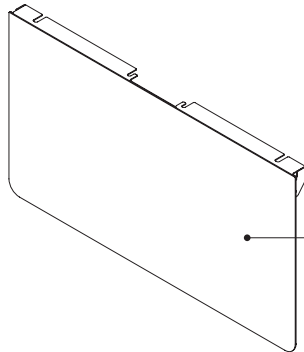

Infill screen is an option to provide modesty on the linear and 120° bench.

Cable Management

Power access door and cable tray provides user access to power and data as well as cord management. Available as an option.

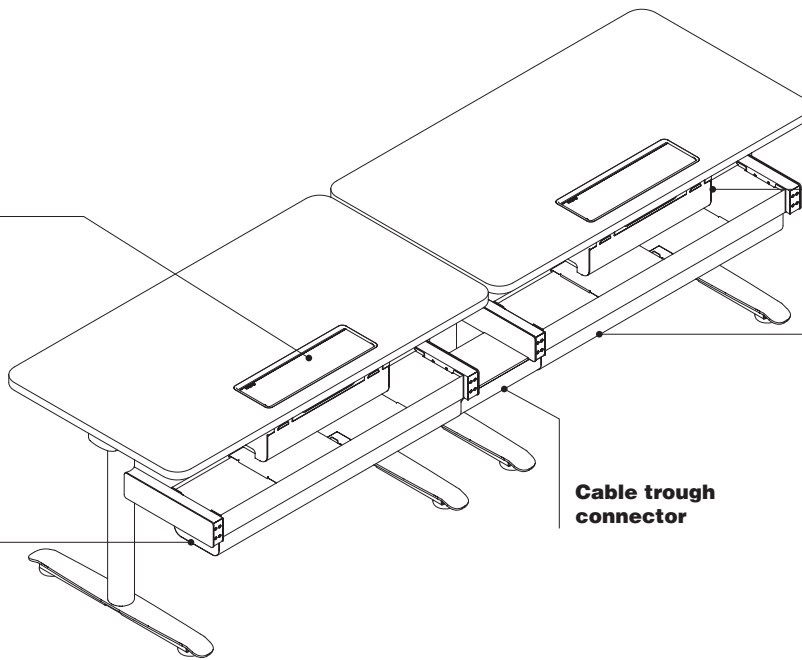

Upper cable tray

Center cable trough – single-sided is available for cord management.

Cable trough connector

End cover

Cable trough connector – Egress

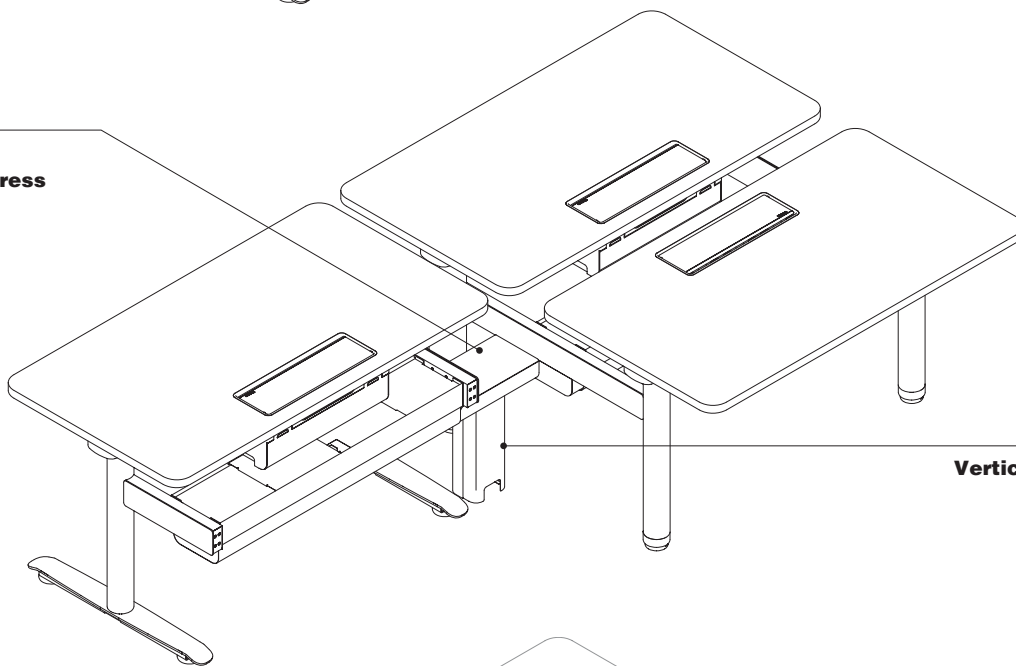

Vertical riser

The support beam is an option for situations where wire routing across the bench is not necessary and replaces the center trough.

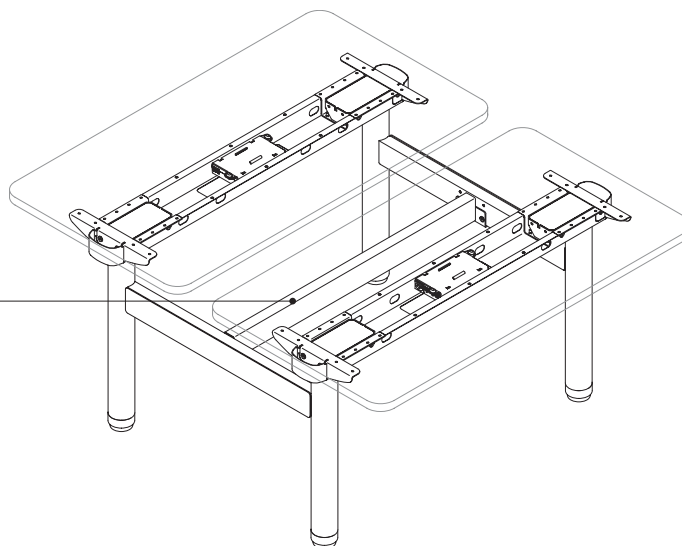

Wiring & Cabling

The central trough runs between the legs of the bench to hold cables for power and data, including power housing. The central trough comes equipped with covers.

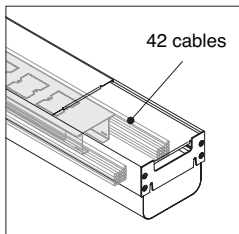

With hardwire and softwire housing

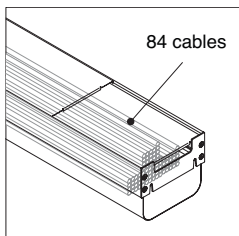

Without hardwire and softwire housing

The center trough has 3 capacity options, reduced, basic and expanded. Basic accommodates 38 total 9mm diameter cables with hardwire and softwire housing options or 76 total without. Extended accommodates 84 total 9mm diameter cables with hardwire and softwire housing options or 120 total without. Reduced accommodates 10 total 9mm diameter cables without hardwiring.

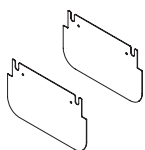

End cover for central cable trough allows for a finished look on the end of the trough.

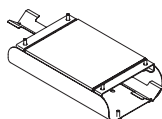

Cable trough connector

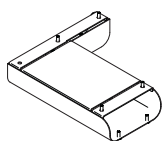

Cable trough connector – Egress

Cable trough connector links the center cable trough between two benches to manage cabling between benches.

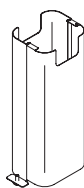

Vertical riser accommodates a large capacity of hardwire conduit and other cabling.

Power access doors allow for easy user access into the upper tray.

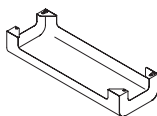

Simple

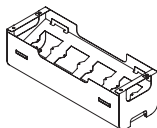

Metal

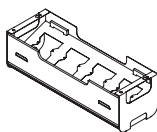

Metal-PET

Upper tray provides housing for power and data ports, and can be hardwired and soft-wired. Hardwiring available only for metal/metal-PET tray.

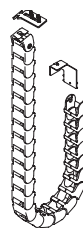

Cable chain – trough to upper tray



Cable chain – floor infeed

Cable chain is available for light to medium cabling needs, can accommodate up to 6 pieces of 9mm cables. For application with cable conduit, please use high capacity cable chain instead. Cable chain is available in Merle color.

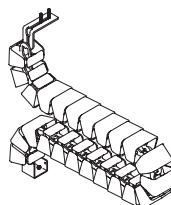

High Capacity Cable Chain for heavy cabling needs, can accommodate up to 10 pieces of 9mm wire. This cable chain has two separated compartments for data and power.

Worksurface Options Matrix

Style Number	Description
MGDEWSVQ	120 Degree Worksurface For Desk
MGBEWSVQ	120 Degree Worksurface For Bench
MGDEWSLQ	90 Degree Desk Worksurface

Worksurface Profile	Power Cutout	Controller Mount
Corner profile: Square Edge, Round Edge	Flipper Left	Bottom Left
		Top Left
		None
	Flipper Right	Bottom Right
		Top Right
		None
No Flipper	Bottom Left, Bottom Right	
	Top Left, Top Right	
	None	

Style Number	Description
MGDEWSRQ	Rectangular Worksurface For Desk
MGBEWSRQ	Rectangular Worksurface For Bench

Worksurface Profile	Power Cutout	Controller Mount
Corner profile: Square Edge, Round Edge, Flex Edge	Flipper	Top Left, Top Right
		None
		None
No Flipper	No Flipper	Top Left, Top Right
		None
		None

Style Number	Description
MGBEWSLQ	90 Degree Bench Worksurface

Worksurface Profile	Power Cutout	Power Cutout Position
Focus Left, Focus Right	AHMEYEHYHB, NOHB	N.A.
		N.A.
Team Left	AHMEYEHYHB	Top Left
		Top Left
	NOHB	N.A.
		N.A.
Team Right	AHMEYEHYHB	Top Right
		Top Right
	NOHB	N.A.
		N.A.

Controller Cutout	Base	Base Controller
None	Basic & Extended Height	Up/Down, 4-Preset
3-Preset Int, Simple Int	Basic & Extended Height	3-Preset Int, Simple Int
None	Fixed Height	N.A.
None	Basic & Extended Height	Up/Down, 4-Preset
3-Preset Int, Simple Int	Basic & Extended Height	3-Preset Int, Simple Int
None	Fixed Height	N.A.
None	Basic & Extended Height	Up/Down, 4-Preset
3-Preset Int, Simple Int	Basic & Extended Height	3-Preset Int, Simple Int
None	Fixed Height	N.A.

Controller Cutout	Base	Base Controller
3-Preset Int, Simple Int	Basic & Extended Height	3-Preset Int, Simple Int
None	Basic & Extended Height	Up/Down, 4-Preset
None	Fixed Height	N.A.
3-Preset Int, Simple Int	Basic & Extended Height	3-Preset Int, Simple Int
None	Basic & Extended Height	Up/Down, 4-Preset
None	Fixed Height	N.A.

Controller Mount	Controller Cutout	Base	Base Controller
N.A.	3-Preset Int, Simple Int	Basic & Extended Height	3-Preset Int, Simple Int
N.A.	None	Fixed Height	N.A.
Side, Top Left	3-Preset Int, Simple Int	Basic & Extended Height	3-Preset Int, Simple Int
None	None	Fixed Height	N.A.
Side, Top Left	3-Preset Int, Simple Int	Basic & Extended Height	3-Preset Int, Simple Int
None	None	Fixed Height	N.A.
Side, Top Right	3-Preset Int, Simple Int	Basic & Extended Height	3-Preset Int, Simple Int
None	None	Fixed Height	N.A.
Side, Top Right	3-Preset Int, Simple Int	Basic & Extended Height	3-Preset Int, Simple Int
None	None	Fixed Height	N.A.

Worksurface Options Visualized

Controller Options

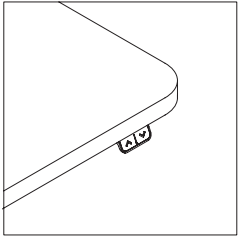

Up/Down controller

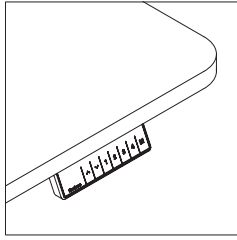

4 Preset controller

The above controller options are mounted underneath the worksurface on left or right hand side.
Specification tips: select **none** for controller cutout, and select **none** for controller mount position.

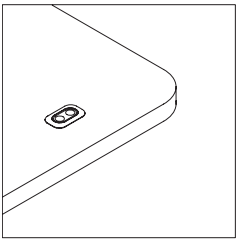

Simple integrated controller

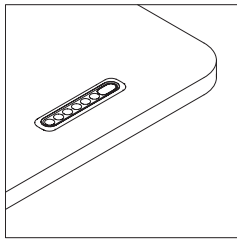

3 Preset integrated controller

The above controller options are mounted into a cutout in the worksurface, on left or right hand side.
Specification tips: select **simple integrated controller** or **3 Preset controller** for controller cutout, and select **top left** or **top right** for controller mount position.

Power Options

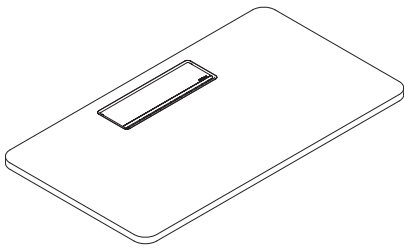

Flipper

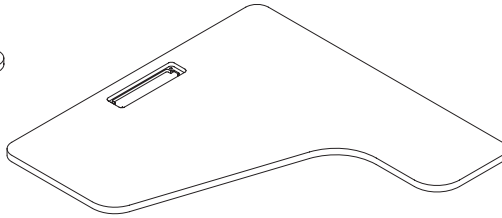

AH Meyer cutout (only applicable on 90 degree bench)

Worksurface

Linear Worksurface – for Desk & Bench

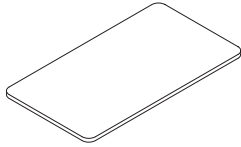

No flipper



With flipper

Tip: See Worksurface Option Matrix, page 24-25 for further information on options availability.

Tip: For worksurface integrated controllers, select simple integrated controller or 3 Preset controller for controller cutout, and select top left or top right for controller mount position.

Tip: For under worksurface mounted controllers select none for controller cutout, and select none for controller mount position.

Standard Includes	Required to Specify
<ul style="list-style-type: none"> • Worksurface: Low-pressure laminate with 2mm plastic edge • Depth: 700-900mm • Width: 1200-1800mm 	<ol style="list-style-type: none"> 1 Style number 2 Laminate color number 3 Edge color number 4 Flipper options (see below under Required Selections) 5 Corner profile (see below under Required Selections) 6 Edge profile (see below under Required Selections) 7 Controller cutout (see below under Required Selections) 8 Controller mount position (see below under Required Selections) 9 Options, if selected

	Required Selections	List Price	Required to Specify
Flipper	<ul style="list-style-type: none"> • No flipper • Flipper 	No cost +\$39	Specify <i>with no flipper</i> . Specify <i>with flipper</i> .
Corner Profile	<ul style="list-style-type: none"> • Square corners • Rounded corners • Flex corners 	No cost No cost No cost	Specify <i>with square corners</i> . Specify <i>with rounded corners</i> . Specify <i>with flex corners</i> .
Edge Profile	<ul style="list-style-type: none"> • Straight edge • Chamfered edge 	No cost No cost	Specify <i>with straight edge</i> . Specify <i>with chamfered edge</i> .
Controller Cutout	<ul style="list-style-type: none"> • None • Simple integrated controller • 3 pre-set integrated controller 	No cost No cost No cost	Specify <i>with none</i> . Specify <i>with simple integrated controller</i> . Specify <i>with 3 pre-set integrated controller</i> .
Controller Mount Position	<ul style="list-style-type: none"> • None • Left • Right 	No cost No cost No cost	Specify <i>with none</i> . Specify <i>with left</i> . Specify <i>with right</i> .

	Options	List Price	Required to Specify
Surface Materials	Flipper door color scheme		
	<ul style="list-style-type: none"> • Light/light • Dark/dark 	No cost No cost	Specify <i>with light/light color scheme</i> . Specify <i>with dark/dark color scheme</i> .
	Chamfered edge paint		
	<ul style="list-style-type: none"> • White • Black • Clear coat 	No cost No cost No cost	Specify <i>with white</i> . Specify <i>with black</i> . Specify <i>with clear coat</i> .

Specification Information						
Style Number	Dimension D	Base Prices (USD)				
		1200W	1400W	1500W	1600W	1800W

Linear Worksurface for Desk — Straight Edge

Style Number	Dimension D	1200W	1400W	1500W	1600W	1800W
MGDEWSRQ	700	\$141	\$165	\$173	\$181	\$191
	750	\$148	\$171	\$180	\$187	\$197
	800	\$153	\$176	\$185	\$192	\$202
	900	\$158	\$182	\$190	\$197	\$207

► **Specification Information, continued on next page**

► **Specification Information, continued from previous page**

Specification Information

• Style Number	• Dimension D	• Base Prices (USD)				
		1200W	1400W	1500W	1600W	1800W

Linear Worksurface for Desk — Chamfered Edge (Clear Coat)

MGDEWSRQ	700	\$222	\$304	\$314	\$320	\$335
	750	\$232	\$314	\$325	\$330	\$345
	800	\$237	\$325	\$335	\$340	\$356
	900	\$247	\$334	\$345	\$350	\$366

Linear Worksurface for Desk — Chamfered Edge (Merle/White)

MGDEWSRQ	700	\$386	\$489	\$505	\$520	\$551
	750	\$402	\$510	\$520	\$541	\$566
	800	\$417	\$520	\$541	\$551	\$582
	900	\$433	\$541	\$551	\$566	\$597

Linear Worksurface for Bench — Straight Edge

MGBEWSRQ	700	\$141	\$165	\$173	\$181	\$191
	750	\$148	\$171	\$180	\$187	\$197
	800	\$153	\$176	\$185	\$192	\$202
	900	\$158	\$182	\$190	\$197	\$207

Linear Worksurface for Bench — Chamfered Edge (Clear Coat)

MGBEWSRQ	700	\$222	\$304	\$314	\$320	\$335
	750	\$232	\$314	\$325	\$330	\$345
	800	\$237	\$325	\$335	\$340	\$356
	900	\$247	\$334	\$345	\$350	\$366

Linear Worksurface for Bench — Chamfered Edge (Merle/White)

MGBEWSRQ	700	\$386	\$489	\$505	\$520	\$551
	750	\$402	\$510	\$520	\$541	\$566
	800	\$417	\$520	\$541	\$551	\$582
	900	\$433	\$541	\$551	\$566	\$597

90° Worksurface – for Desk

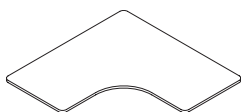

Tip: Specify Left grain direction for grain running parallel to left hand flipper, or right grain direction for grain running parallel to right hand flipper.

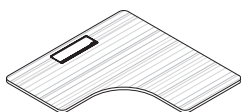

Left grain direction

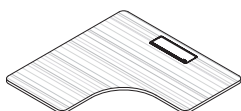

Right grain direction

Tip: See Worksurface Option Matrix, page 24-25 for further information on options availability.

Tip: For worksurface integrated controllers, select simple integrated controller or 3 Preset controller for controller cutout, and select top left or top right for controller mount position.

Tip: For under worksurface mounted controllers select none for controller cutout, and select none for controller mount position.

Standard Includes	Required to Specify
-------------------	---------------------

- Worksurface: Low-pressure laminate with 2mm plastic edge
- Depth: 700-800mm
- Width: 1400-1800mm

- 1 Style number
- 2 Laminate color number
- 3 Edge color number
- 4 Grain direction (see below under Required Selections)
- 5 Flipper options (see below under Required Selections)
- 6 Corner profile (see below under Required Selections)
- 7 Edge profile (see below under Required Selections)
- 8 Controller cutout (see below under Required Selections)
- 9 Controller mount position (see below under Required Selections)
- 10 Options, if selected

	Required Selections	List Price	Required to Specify
--	---------------------	------------	---------------------

Grain Direction	<ul style="list-style-type: none"> • Left • Right 	No cost No cost	Specify <i>with left</i> . Specify <i>with right</i> .
Flipper	<ul style="list-style-type: none"> • No flipper • Flipper 	No cost +\$39	Specify <i>with no flipper</i> . Specify <i>with flipper</i> .
Corner Profile	<ul style="list-style-type: none"> • Square corners • Rounded corners 	No cost No cost	Specify <i>with square corners</i> . Specify <i>with rounded corners</i> .
Edge Profile	<ul style="list-style-type: none"> • Straight edge • Chamfered edge 	Prices below Prices below	Specify <i>with straight edge</i> . Specify <i>with chamfered edge</i> .
Controller Cutout	<ul style="list-style-type: none"> • None • Simple integrated controller • 3 pre-set integrated controller 	No cost No cost No cost	Specify <i>with none</i> . Specify <i>with simple integrated controller</i> . Specify <i>with 3 pre-set integrated controller</i> .
Controller Mount Position	<ul style="list-style-type: none"> • None • Left • Right 	No cost No cost No cost	Specify <i>with none</i> . Specify <i>with left</i> . Specify <i>with right</i> .

	Options	List Price	Required to Specify
--	---------	------------	---------------------

Surface Materials	Flipper door color scheme <ul style="list-style-type: none"> • Light/light • Dark/dark 	No cost No cost	Specify <i>with light/light color scheme</i> . Specify <i>with dark/dark color scheme</i> .
	Chamfered edge paint <ul style="list-style-type: none"> • White • Black • Clear coat 	Prices below Prices below Prices below	Specify <i>with white</i> . Specify <i>with black</i> . Specify <i>with clear coat</i> .

► Specification Information, continued on next page

► **Specification Information, continued from previous page**

Specification Information

• Style Number	• Dimension D	• Base Prices (USD)		
		1400W	1600W	1800W

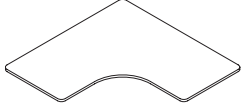

Straight Edge

MGDEWSLQ	Dimension D	1400W	1600W	1800W
	700	\$371	\$413	\$423
	750	\$392	\$433	\$444
	800	N.A.	\$444	\$454

Chamfered Edge – Clear Coat

MGDEWSLQ	Dimension D	1400W	1600W	1800W
	700	\$438	\$521	\$582
	750	\$469	\$557	\$690
	800	N.A.	\$577	\$711

Chamfered Edge – Merle/White

MGDEWSLQ	Dimension D	1400W	1600W	1800W
	700	\$567	\$675	\$757
	750	\$603	\$721	\$871
	800	N.A.	\$747	\$896

120° Worksurface – for Desk & Bench

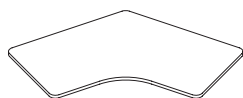

Tip: Specify Left grain direction for grain running parallel to left hand flipper, or right grain direction for grain running parallel to right hand flipper.

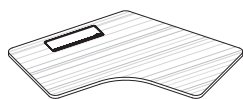

Left grain direction



Right grain direction

Tip: See Worksurface Option Matrix, page 24-25 for further information on options availability.

Tip: For worksurface integrated controllers, select simple integrated controller or 3 Preset controller for controller cutout, and select top left or top right for controller mount position.

Tip: For under worksurface mounted controllers select none for controller cutout, and select none for controller mount position.

Standard Includes		Required to Specify	
<ul style="list-style-type: none"> • Worksurface: Low-pressure laminate with 2mm plastic edge • Depth: 700-800mm • Width: 1200-1600mm 		<ol style="list-style-type: none"> 1 Style number 2 Laminate color number 3 Edge color number 4 Grain direction (see below under Required Selections) 5 Flipper options (see below under Required Selections) 6 Corner profile (see below under Required Selections) 7 Edge profile (see below under Required Selections) 8 Controller cutout (see below under Required Selections) 9 Controller mount position (see below under Required Selections) 10 Options, if selected 	

Required Selections		List Price	Required to Specify
Grain Direction	Applicable to W1600 top only <ul style="list-style-type: none"> • Left • Right 	No cost No cost	Specify <i>with left</i> . Specify <i>with right</i> .
Flipper	<ul style="list-style-type: none"> • No flipper • Flipper 	No cost +\$39	Specify <i>with no flipper</i> . Specify <i>with flipper</i> .
Corner Profile	<ul style="list-style-type: none"> • Square corners • Rounded corners 	No cost No cost	Specify <i>with square corners</i> . Specify <i>with rounded corners</i> .
Edge Profile	<ul style="list-style-type: none"> • Straight edge • Chamfered edge 	Prices below Prices below	Specify <i>with straight edge</i> . Specify <i>with chamfered edge</i> .
Controller Cutout	<ul style="list-style-type: none"> • None • Simple integrated controller • 3 pre-set integrated controller 	No cost No cost No cost	Specify <i>with none</i> . Specify <i>with simple integrated controller</i> . Specify <i>with 3 pre-set integrated controller</i> .
Controller Mount Position	<ul style="list-style-type: none"> • None • Left • Right 	No cost No cost No cost	Specify <i>with none</i> . Specify <i>with left</i> . Specify <i>with right</i> .

Options		List Price	Required to Specify
Surface Materials	Flipper door color scheme		
	<ul style="list-style-type: none"> • Light/light • Dark/dark 	No cost No cost	Specify <i>with light/light color scheme</i> . Specify <i>with dark/dark color scheme</i> .
	Chamfered edge paint		
	<ul style="list-style-type: none"> • White • Black • Clear coat 	Prices below Prices below Prices below	Specify <i>with white</i> . Specify <i>with black</i> . Specify <i>with clear coat</i> .

► Specification Information, continued on next page

Migration SE Pro

► **Specification Information, continued from previous page**

Specification Information

• Style • Number	• Dimension • D	• Base Prices (USD)		
		• 1200W	• 1400W	• 1600W



120° Worksurface for Desk — Straight Edge

MGDEWSVQ	Dimension	1200W	1400W	1600W
	700	\$361	\$413	\$434
	750	\$434	\$485	\$506
	800	\$454	\$506	\$526

120° Worksurface for Desk — Chamfered Edge (Clear Coat)

MGDEWSVQ	Dimension	1200W	1400W	1600W
	700	\$485	\$675	\$717
	750	\$660	\$758	\$799
	800	\$691	\$789	\$830

120° Worksurface for Desk — Chamfered Edge (Merle/White)

MGDEWSVQ	Dimension	1200W	1400W	1600W
	700	\$567	\$773	\$835
	750	\$742	\$855	\$917
	800	\$778	\$886	\$948

► **Specification Information, continued on next page**

► Specification Information, continued from previous page

Specification Information

• Style Number	• Dimension D	• Base Prices (USD)			
		1000W	1200W	1400W	1600W

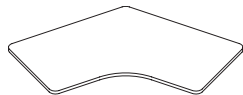

120° Worksurface for Bench 2-Leg — Straight Edge

MGBEWSVQ	700	\$340	\$361	N.A.	N.A.
	750	\$413	\$433	N.A.	N.A.
	800	N.A.	\$454	N.A.	N.A.
	:	:	:	:	:

120° Worksurface for Bench 2-Leg — Chamfered Edge (Clear Coat)

MGBEWSVQ	700	\$454	\$485	N.A.	N.A.
	750	\$557	\$659	N.A.	N.A.
	800	N.A.	\$690	N.A.	N.A.
	:	:	:	:	:

120° Worksurface for Bench 2-Leg — Chamfered Edge (Merle/White)

MGBEWSVQ	700	\$485	\$567	N.A.	N.A.
	750	\$639	\$742	N.A.	N.A.
	800	N.A.	\$778	N.A.	N.A.
	:	:	:	:	:

120° Worksurface for Bench 3-Leg — Straight Edge

MGBEWSVQ	700	N.A.	N.A.	\$413	\$433
	750	N.A.	N.A.	\$485	\$505
	800	N.A.	N.A.	\$505	\$526
	:	:	:	:	:

120° Worksurface for Bench 3-Leg — Chamfered Edge (Clear Coat)

MGBEWSVQ	700	N.A.	N.A.	\$675	\$716
	750	N.A.	N.A.	\$757	\$798
	800	N.A.	N.A.	\$788	\$829
	:	:	:	:	:

120° Worksurface for Bench 3-Leg — Chamfered Edge (Merle/White)

MGBEWSVQ	700	N.A.	N.A.	\$773	\$834
	750	N.A.	N.A.	\$855	\$917
	800	N.A.	N.A.	\$886	\$948
	:	:	:	:	:

Migration SE Pro

90° Worksurface – for Bench



Focus worksurface

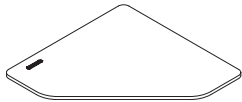

Team worksurface

Tip: See Worksurface Option Matrix, page 22-23 for further information on options availability.

Tip: For worksurface integrated controllers, select simple integrated controller or 3 Preset controller for controller cutout, and select top left or top right for controller mount position.

Tip: For under worksurface mounted controllers select none for controller cutout, and select none for controller mount position.

Standard Includes		Required to Specify	
<ul style="list-style-type: none"> • Worksurface: Low-pressure laminate with 2mm plastic edge 		<ol style="list-style-type: none"> 1 Style number 2 Laminate color number 3 Edge color number 4 Flipper options (see below under Required Selections) 5 Edge profile (see below under Required Selections) 6 Controller cutout (see below under Required Selections) 7 Controller mount position (see below under Required Selections) 8 Options, if selected 	

	Required Selections	List Price	Required to Specify
Top Profile	<ul style="list-style-type: none"> • Team • Focus 	No cost No cost	Specify <i>with team</i> . Specify <i>with focus</i> .
Power Position	Applicable for team top only <ul style="list-style-type: none"> • Left • Right 	No cost No cost	Specify <i>with left</i> . Specify <i>with right</i> .
Edge Profile	<ul style="list-style-type: none"> • Straight edge • Chamfered edge 	Prices below Prices below	Specify <i>with straight edge</i> . Specify <i>with chamfered edge</i> .
Controller Cutout	<ul style="list-style-type: none"> • None • Simple integrated controller • 3 pre-set integrated controller 	No cost No cost No cost	Specify <i>with none</i> . Specify <i>with simple integrated controller</i> . Specify <i>with 3 pre-set integrated controller</i> .
Controller Mount Position	<ul style="list-style-type: none"> • None • Left • Right 	No cost No cost No cost	Specify <i>with none</i> . Specify <i>with left</i> . Specify <i>with right</i> .

	Options	List Price	Required to Specify
Worktop Power Option	<ul style="list-style-type: none"> • No cutout • AH Meyer cutout 	No cost +\$33	Specify <i>with no cutout</i> . Specify <i>with AH Meyer cutout</i> .
Surface Materials	Chamfered edge paint <ul style="list-style-type: none"> • White • Black • Clear coat AH Meyer cutout plate finish <ul style="list-style-type: none"> • Paint price group 1 • Paint price group 2 • Paint price group 3 	Prices below Prices below Prices below No cost +\$7 +\$9	Specify <i>with white</i> . Specify <i>with black</i> . Specify <i>with clear coat</i> . Specify paint color number. Specify paint color number. Specify paint color number.

► **Specification Information, continued on next page**

► **Specification Information, continued from previous page**

Specification Information

• Style Number	• Dimension D	• Base Price (USD)
		1200W

90° Worksurface for Bench — Straight Edge

MGBEWSLQ	1200	\$371
:	:	:

90° Worksurface for Bench — Chamfered Edge (Clear Coat)

MGBEWSLQ	1200	\$428
:	:	:

90° Worksurface for Bench — Chamfered Edge (Merle/White)

MGBEWSLQ	1200	\$552
:	:	:

Worksurface – for Meeting Table

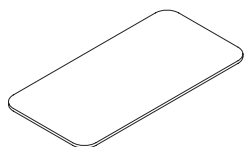

Rectangular

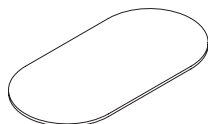

Pill

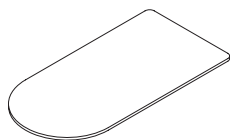

Flat Edge

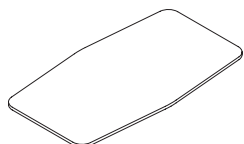

Hexagon

Standard Includes	Required to Specify
-------------------	---------------------

- Worksurface: Low-pressure laminate with 2mm plastic edge
- Depth: 900mm
- Width: 1800–2200mm

- 1 Style number
- 2 Laminate color number
- 3 Edge color number
- 4 Edge profile (see below under Required Selections)
- 5 Top shape (see below under Required Selections)
- 6 Controller cutout (see below under Required Selections)
- 7 Controller mount position (see below under Required Selections)
- 8 Power cutout (see below under Required Selections)
- 9 Options, if selected

Required Selections	List Price	Required to Specify
---------------------	------------	---------------------

Edge Profile	<ul style="list-style-type: none"> • Straight edge • Chamfered edge 	No cost No cost	Specify <i>with straight edge</i> . Specify <i>with chamfered edge</i> .
Top Shape	<ul style="list-style-type: none"> • Rectangular • Pill • Flat edge • Hexagon 	No cost No cost No cost No cost	Specify <i>with rectangular top</i> . Specify <i>with pill top</i> . Specify <i>with flat edge top</i> . Specify <i>with hexagon top</i> .
Controller Cutout	<ul style="list-style-type: none"> • None • Simple integrated controller • Double simple integrated controller • 3 pre-set integrated controller 	No cost No cost No cost No cost	Specify <i>with none</i> . Specify <i>with simple integrated controller</i> . Specify <i>with double simple integrated controller</i> . Specify <i>with 3 pre-set integrated controller</i> .
Controller Mount Position	<ul style="list-style-type: none"> • None • Left • Right 	No cost No cost No cost	Specify <i>with none</i> . Specify <i>with left</i> . Specify <i>with right</i> .
Worktop Power Option	<ul style="list-style-type: none"> • No cutout • AH Meyer cutout 	No cost +\$33	Specify <i>with no cutout</i> . Specify <i>with AH Meyer cutout</i> .

Options	List Price	Required to Specify
---------	------------	---------------------

Surface Materials	Chamfered edge paint <ul style="list-style-type: none"> • White • Black • Clear coat 	No cost No cost No cost	Specify <i>with white</i> . Specify <i>with black</i> . Specify <i>with clear coat</i> .
	AH Meyer cutout plate finish <ul style="list-style-type: none"> • Paint price group 1 • Paint price group 2 • Paint price group 3 	No cost +\$7 +\$9	Specify paint color number. Specify paint color number. Specify paint color number.

Specification Information		
---------------------------	--	--

• Style Number	• Dimension D	• Base Price (USD)
		1800W : 2200W

Worksurface for Meeting Table

MGMEWSMQ	900*	\$250	\$270
-----------------	------	-------	-------

*Hexagon worksurface max depth at center is 1000D, at either end is 800D.

Base for Desk

Base for Linear Desk

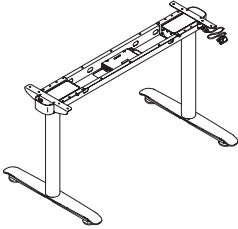

Standard Includes	Required to Specify
<ul style="list-style-type: none"> • Electric height-adjustable sit-to-stand base: paint • Power cord length: 3 meter • 25mm glides • Attachment hardware • Up/down controller (not applicable for fixed height) • Plugs 	<ol style="list-style-type: none"> 1 Style number 2 Paint color for base 3 Leg column (see below under Required Selections) 4 Top depth (see below under Required Selections) 5 Top width (see below under Required Selections) 6 Power solutions (see below under Required Selections) 7 Options, if selected (see below)

	Required Selections	List Price	Required to Specify
Leg Column	<ul style="list-style-type: none"> • Rectangular • Round 	No cost No cost	Specify with <i>rectangular leg column</i> . Specify with <i>round leg column</i> .
For Top Depth	<ul style="list-style-type: none"> • D700 • D750 • D800 • D900 	No cost No cost +\$17 +\$17	Specify with <i>D700 top depth</i> . Specify with <i>D750 top depth</i> . Specify with <i>D800 top depth</i> . Specify with <i>D900 top depth</i> .
For Top Width	<ul style="list-style-type: none"> • W1200 • W1400 • W1500 • W1600 • W1800 	No cost No cost No cost No cost No cost	Specify with <i>W1200 top width</i> . Specify with <i>W1400 top width</i> . Specify with <i>W1500 top width</i> . Specify with <i>W1600 top width</i> . Specify with <i>W1800 top width</i> .
Power Solutions	<ul style="list-style-type: none"> • Australia/New Zealand • Bangladesh • China • Hong Kong • India • Indonesia • Japan • Korea • Macau • Malaysia • Myanmar • Philippines • Singapore • Sri Lanka • Taiwan • Thailand • Vietnam 	No cost No cost No cost No cost No cost No cost No cost No cost No cost No cost No cost No cost No cost No cost No cost No cost	Specify with <i>Australia/New Zealand power</i> . Specify with <i>Bangladesh power</i> . Specify with <i>China power</i> . Specify with <i>Hong Kong power</i> . Specify with <i>India power</i> . Specify with <i>Indonesia power</i> . Specify with <i>Japan power</i> . Specify with <i>Korea power</i> . Specify with <i>Macau power</i> . Specify with <i>Malaysia power</i> . Specify with <i>Myanmar power</i> . Specify with <i>Philippines power</i> . Specify with <i>Singapore power</i> . Specify with <i>Sri Lanka power</i> . Specify with <i>Taiwan power</i> . Specify with <i>Thailand power</i> . Specify with <i>Vietnam power</i> .

► Option, continued on next page

► **Option, continued from previous page**

	Options	List Price	Required to Specify
Surface Materials	Upper base		
	• Paint price group 1	No cost	Specify paint color number.
	• Paint price group 2	+\$17	Specify paint color number.
	• Paint price group 3	+\$23	Specify paint color number.
	Lower base		
	• Paint price group 1	No cost	Specify paint color number.
• Paint price group 2	+\$17	Specify paint color number.	
• Paint price group 3	+\$23	Specify paint color number. ► See <i>Surface Materials</i> , page 69	
Controller	For basic and extended height only		
	• Up/down controller	No cost	Specify <i>with up/down controller</i> .
	• 4 pre-set controller	+\$54	Specify <i>with 4 pre-set controller</i> .
	• Simple integrated controller	+\$54	Specify <i>with simple integrated controller</i> .
• 3 pre-set integrated controller	+\$54	Specify <i>with 3 pre-set integrated controller</i> .	
Related Products	• Cable and power management		► Page 60

Specification Information

Height Range	Worksurface Dimensions D : W	Style Number	List Price (USD)
Fixed Height	700 – 900 1200-1800	MGDFLRQB	\$584
Basic Height	700 – 900 1200-1800	MGDBLRQB	\$1,008
Extended Height	700 – 900 1200-1800	MGDELRQB	\$1,114

Base for 90° Desk

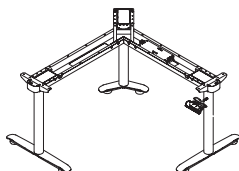

Standard Includes		Required to Specify	
<ul style="list-style-type: none"> • Electric height-adjustable sit-to-stand base: paint • Power cord length: 3 meter • 25mm glides • Attachment hardware • Up/down controller (not applicable for fixed height) • Plugs 		<ol style="list-style-type: none"> 1 Style number 2 Paint color for base 3 Leg column (see below under Required Selections) 4 Top depth (see below under Required Selections) 5 Top width (see below under Required Selections) 6 Options, if selected (see below) 	
Required Selections		List Price	Required to Specify
Leg Column	<ul style="list-style-type: none"> • Rectangular • Round 	No cost No cost	Specify with <i>rectangular leg column</i> . Specify with <i>round leg column</i> .
For Top Depth	<ul style="list-style-type: none"> • D700 • D750 • D800 	No cost No cost +\$17	Specify with <i>D700 top depth</i> . Specify with <i>D750 top depth</i> . Specify with <i>D800 top depth</i> .
For Top Width	<ul style="list-style-type: none"> • W1200 • W1400 • W1500 • W1600 • W1800 	No cost No cost No cost No cost No cost	Specify with <i>W1200 top width</i> . Specify with <i>W1400 top width</i> . Specify with <i>W1500 top width</i> . Specify with <i>W1600 top width</i> . Specify with <i>W1800 top width</i> .
Power Solutions	<ul style="list-style-type: none"> • Australia/New Zealand • Bangladesh • China • Hong Kong • India • Indonesia • Japan • Korea • Macau • Malaysia • Myanmar • Philippines • Singapore • Sri Lanka • Taiwan • Thailand • Vietnam 	No cost No cost No cost No cost No cost No cost No cost No cost No cost No cost No cost No cost No cost No cost No cost No cost No cost No cost	Specify with <i>Australia/New Zealand power</i> . Specify with <i>Bangladesh power</i> . Specify with <i>China power</i> . Specify with <i>Hong Kong power</i> . Specify with <i>India power</i> . Specify with <i>Indonesia power</i> . Specify with <i>Japan power</i> . Specify with <i>Korea power</i> . Specify with <i>Macau power</i> . Specify with <i>Malaysia power</i> . Specify with <i>Myanmar power</i> . Specify with <i>Philippines power</i> . Specify with <i>Singapore power</i> . Specify with <i>Sri Lanka power</i> . Specify with <i>Taiwan power</i> . Specify with <i>Thailand power</i> . Specify with <i>Vietnam power</i> .

► Option, continued on next page

► Option, continued from previous page

	Options	List Price	Required to Specify
Surface Materials	Upper base		
	• Paint price group 1	No cost	Specify paint color number.
	• Paint price group 2	+\$17	Specify paint color number.
	• Paint price group 3	+\$23	Specify paint color number.
	Lower base		
	• Paint price group 1	No cost	Specify paint color number.
• Paint price group 2	+\$17	Specify paint color number.	
• Paint price group 3	+\$23	Specify paint color number. ► See <i>Surface Materials</i> , page 69	
Controller	For basic and extended height only		
	• Up/down controller	No cost	Specify <i>with up/down controller</i> .
	• 4 pre-set controller	+\$54	Specify <i>with 4 pre-set controller</i> .
	• Simple integrated controller	No cost	Specify <i>with simple integrated controller</i> .
• 3 pre-set integrated controller	+\$54	Specify <i>with 3 pre-set integrated controller</i> .	
Egress Arm	• Egress arm bridge	+\$62	Specify <i>with egress arm bridge</i> .
Related Products	• Cable and power management		► Page 60

Specification Information

• Height • Range	• Worksurface • Dimensions • D	• W	• Style • Number	• List • Price • (USD)
Fixed Height	700 – 900	1200-1800	MGDFLLQB	\$669
Basic Height	700 – 900	1200-1800	MGDBLLQB	\$1,287
Extended Height	700 – 900	1200-1800	MGDELLQB	\$1,390
•	•	•	•	•

Base for 120° Desk

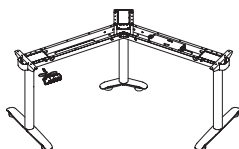

Standard Includes		Required to Specify	
<ul style="list-style-type: none"> • Electric height-adjustable sit-to-stand base: paint • Power cord length: 3 meter • 25mm glides • Attachment hardware • Up/down controller (not applicable for fixed height) • Plugs 		<ol style="list-style-type: none"> 1 Style number 2 Paint color for base 3 Leg column (see below under Required Selections) 4 Top depth (see below under Required Selections) 5 Top width (see below under Required Selections) 6 Options, if selected (see below) 	
	Required Selections	List Price	Required to Specify
Leg Column	<ul style="list-style-type: none"> • Rectangular • Round 	No cost No cost	Specify with <i>rectangular leg column</i> . Specify with <i>round leg column</i> .
For Top Depth	<ul style="list-style-type: none"> • D700 • D750 • D800 	No cost No cost +\$17	Specify with <i>D700 top depth</i> . Specify with <i>D750 top depth</i> . Specify with <i>D800 top depth</i> .
For Top Width	<ul style="list-style-type: none"> • W1200 • W1400 • W1500 • W1600 • W1800 	No cost No cost No cost No cost No cost	Specify with <i>W1200 top width</i> . Specify with <i>W1400 top width</i> . Specify with <i>W1500 top width</i> . Specify with <i>W1600 top width</i> . Specify with <i>W1800 top width</i> .
Power Solutions	<ul style="list-style-type: none"> • Australia/New Zealand • Bangladesh • China • Hong Kong • India • Indonesia • Japan • Korea • Macau • Malaysia • Myanmar • Philippines • Singapore • Sri Lanka • Taiwan • Thailand • Vietnam 	No cost No cost No cost No cost No cost No cost No cost No cost No cost No cost No cost No cost No cost No cost No cost No cost No cost No cost	Specify with <i>Australia/New Zealand power</i> . Specify with <i>Bangladesh power</i> . Specify with <i>China power</i> . Specify with <i>Hong Kong power</i> . Specify with <i>India power</i> . Specify with <i>Indonesia power</i> . Specify with <i>Japan power</i> . Specify with <i>Korea power</i> . Specify with <i>Macau power</i> . Specify with <i>Malaysia power</i> . Specify with <i>Myanmar power</i> . Specify with <i>Philippines power</i> . Specify with <i>Singapore power</i> . Specify with <i>Sri Lanka power</i> . Specify with <i>Taiwan power</i> . Specify with <i>Thailand power</i> . Specify with <i>Vietnam power</i> .

►Option, continued on next page

► Option, continued from previous page

	Options	List Price	Required to Specify
Surface Materials	Upper base		
	• Paint price group 1	No cost	Specify paint color number.
	• Paint price group 2	+\$17	Specify paint color number.
	• Paint price group 3	+\$23	Specify paint color number.
	Lower base		
	• Paint price group 1	No cost	Specify paint color number.
• Paint price group 2	+\$17	Specify paint color number.	
• Paint price group 3	+\$23	Specify paint color number. ► See <i>Surface Materials</i> , page 69	
Controller	For basic and extended height only		
	• Up/down controller	No cost	Specify <i>with up/down controller</i> .
	• 4 pre-set controller	+\$54	Specify <i>with 4 pre-set controller</i> .
	• Simple integrated controller	No cost	Specify <i>with simple integrated controller</i> .
• 3 pre-set integrated controller	+\$54	Specify <i>with 3 pre-set integrated controller</i> .	
Egress Arm	• Egress arm bridge	+\$62	Specify <i>with egress arm bridge</i> .
Related Products	• Cable and power management		► Page 60

Specification Information

• Height • Range	• Worksurface • Dimensions • D	• W	• Style • Number	• List • Price • (USD)
Fixed Height	700 – 900	1200-1800	MGDFLVQB	\$669
Basic Height	700 – 900	1200-1800	MGDBLVQB	\$1,287
Extended Height	700 – 900	1200-1800	MGDELVQB	\$1,390
•	•	•	•	•

Base for Bench

Base for Linear Bench – Single-Sided

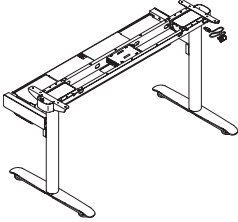

Tip: D800+ single-sided bench requires extended stabilizer foot.

Standard Includes	Required to Specify
<ul style="list-style-type: none"> • Electric height-adjustable sit-to-stand base: paint • Power cord length: 3 meters • 25mm glides • Attachment hardware • Up/down controller (not applicable for fixed height) • Plugs 	<ol style="list-style-type: none"> 1 Style number 2 Paint color number for legs base 3 Leg column (see below under Required Selections) 4 Top depth (see below under Required Selections) 5 Top width (see below under Required Selections) 6 Cable trough type (see below under Required Selections) 7 Controller (see below under Required Selections) 8 Power solutions (see below under Required Selections) 9 Options, if selected (see below)

	Required Selections	List Price	Required to Specify
Leg Column	<ul style="list-style-type: none"> • Rectangular • Round 	No cost No cost	Specify with rectangular leg column. Specify with round leg column.
For Top Depth	<ul style="list-style-type: none"> • D700 • D750 • D800 • D900 	No cost No cost +\$17 +\$17	Specify with D700 top depth. Specify with D750 top depth. Specify with D800 top depth. Specify with D900 top depth.
For Top Width	<ul style="list-style-type: none"> • W1200 • W1400 • W1500 • W1600 • W1800 	No cost No cost No cost No cost No cost	Specify with W1200 top width. Specify with W1400 top width. Specify with W1500 top width. Specify with W1600 top width. Specify with W1800 top width.
Cable Trough Type	<ul style="list-style-type: none"> • Cable trough • No cable trough 	No cost No cost	Specify with cable trough. Specify with no cable trough.
Power Solutions	<p>Country</p> <ul style="list-style-type: none"> • Australia/New Zealand • Bangladesh • China • Hong Kong • India • Indonesia • Japan • Korea • Macau • Malaysia • Myanmar • Philippines • Singapore • Sri Lanka • Taiwan • Thailand • Vietnam 	No cost No cost No cost No cost No cost No cost No cost No cost No cost No cost No cost No cost No cost No cost No cost No cost No cost	Specify with Australia/New Zealand power. Specify with Bangladesh power. Specify with China power. Specify with Hong Kong power. Specify with India power. Specify with Indonesia power. Specify with Japan power. Specify with Korea power. Specify with Macau power. Specify with Malaysia power. Specify with Myanmar power. Specify with Philippines power. Specify with Singapore power. Specify with Sri Lanka power. Specify with Taiwan power. Specify with Thailand power. Specify with Vietnam power.

► Options, continued on next page

► Options, continued from previous page

	Options	List Price	Required to Specify
Surface Materials	Upper base		
	• Paint price group 1	No cost	Specify paint color number.
	• Paint price group 2	+\$17	Specify paint color number.
	• Paint price group 3	+\$23	Specify paint color number.
	Lower base		
	• Paint price group 1	No cost	Specify paint color number.
	• Paint price group 2	+\$17	Specify paint color number.
	• Paint price group 3	+\$23	Specify paint color number.
	Cable Trough		
• Paint price group 1	No cost	Specify paint color number.	
• Paint price group 2	+\$12	Specify paint color number.	
• Paint price group 3	+\$16	Specify paint color number.	
Controller	For basic and extended height only		
	• Up/down controller	No cost	Specify <i>with up/down controller</i> .
	• 4 pre-set controller	+\$12	Specify <i>with 4 pre-set controller</i> .
	• Simple integrated controller	No cost	Specify <i>with simple integrated controller</i> .
	• 3 pre-set integrated controller	+\$16	Specify <i>with 3 pre-set integrated controller</i> .
Cable Trough Capacity	• Basic	No cost	Specify <i>with basic capacity</i> .
	• Reduced (for Metal cable trough only)	No cost	Specify <i>with reduced capacity</i> .
	• Expanded	+\$17	Specify <i>with expanded capacity</i> .
Cable Trough Separator	For basic (with no hardwiring box) and expanded capacity only		
	• Separator	No cost	Specify <i>with separator</i> .
	• No separator	No cost	Specify <i>with no separator</i> .
Hardware/ Software Utility Housing	• No hardwiring box	No cost	Specify <i>with no hardwiring box</i> .
	• Blank cutout hardwiring box	No cost	Specify <i>with blank cutout hardwiring box</i> .
	• 86 x 86 hardwiring box	+\$33	Specify <i>with 86 x 86 hardwiring box</i> .
	• 86 x 86 SCHUKO hardwiring	+\$33	Specify <i>with 86 x 86 SCHUKO hardwiring box</i> .
	• India hardwiring box	+\$33	Specify <i>with India hardwiring box</i> .
	• AH Meyer softwiring box	+\$33	Specify <i>with AH Meyer softwiring box</i> .
	• Australia CMS softwiring box	+\$33	Specify <i>with Australia CMS softwiring box</i> .

Specification Information

• Description	• Dimensions		• Style Number	• List Price (USD)
	• D	• W		
Fixed height	700 – 900	1200 – 1800	MGBSSFLRQB	\$786
Basic height	700 – 900	1200 – 1800	MGBSSBLRQB	\$1,225
Extended height	700 – 900	1200 – 1800	MGBSSELRQB	\$1,331
•	•	•	•	•

Base for Linear Bench – Dual-Sided

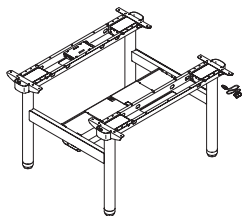

Standard Includes

- Electric height-adjustable sit-to-stand base: paint
- Power cord length: 3 meters
- 25mm glides
- Attachment hardware
- Up/down controller (not applicable for fixed height)
- Plugs

Required to Specify

- 1 Style number
- 2 Paint color number for legs base
- 3 Leg column (see below under Required Selections)
- 4 Top depth (see below under Required Selections)
- 5 Top width (see below under Required Selections)
- 6 Cable trough type (see below under Required Selections)
- 7 Power solutions (see below under Required Selections)
- 8 Options, if selected (see below)

	Required Selections	List Price	Required to Specify
Leg Column	<ul style="list-style-type: none"> • Rectangular • Round 	No cost No cost	Specify with <i>rectangular leg column</i> . Specify with <i>round leg column</i> .
For Top Depth	<ul style="list-style-type: none"> • D700 • D750 • D800 • D900 	No cost No cost No cost No cost	Specify with <i>D700 top depth</i> . Specify with <i>D750 top depth</i> . Specify with <i>D800 top depth</i> . Specify with <i>D900 top depth</i> .
For Top Width	<ul style="list-style-type: none"> • W1200 • W1400 • W1500 • W1600 • W1800 	No cost No cost No cost No cost No cost	Specify with <i>W1200 top width</i> . Specify with <i>W1400 top width</i> . Specify with <i>W1500 top width</i> . Specify with <i>W1600 top width</i> . Specify with <i>W1800 top width</i> .
Power Solutions	<p>Country</p> <ul style="list-style-type: none"> • Australia/New Zealand • Bangladesh • China • Hong Kong • India • Indonesia • Japan • Korea • Macau • Malaysia • Myanmar • Philippines • Singapore • Sri Lanka • Taiwan • Thailand • Vietnam 	No cost No cost No cost No cost No cost No cost No cost No cost No cost No cost No cost No cost No cost No cost No cost No cost No cost	Specify with <i>Australia/New Zealand power</i> . Specify with <i>Bangladesh power</i> . Specify with <i>China power</i> . Specify with <i>Hong Kong power</i> . Specify with <i>India power</i> . Specify with <i>Indonesia power</i> . Specify with <i>Japan power</i> . Specify with <i>Korea power</i> . Specify with <i>Macau power</i> . Specify with <i>Malaysia power</i> . Specify with <i>Myanmar power</i> . Specify with <i>Philippines power</i> . Specify with <i>Singapore power</i> . Specify with <i>Sri Lanka power</i> . Specify with <i>Taiwan power</i> . Specify with <i>Thailand power</i> . Specify with <i>Vietnam power</i> .

► Options, continued on next page

► Options, continued from previous page

	Options	List Price	Required to Specify
Surface Materials	Upper Base		
	• Paint price group 1	No cost	Specify paint color number.
	• Paint price group 2	+\$27	Specify paint color number.
	• Paint price group 3	+\$37	Specify paint color number.
	Lower base		
	• Paint price group 1	No cost	Specify paint color number.
	• Paint price group 2	+\$27	Specify paint color number.
	• Paint price group 3	+\$37	Specify paint color number.
	Cable Trough		
• Paint price group 1	No cost	Specify paint color number.	
• Paint price group 2	+\$12	Specify paint color number.	
• Paint price group 3	+\$16	Specify paint color number.	
Controller	For basic and extended height only		
	• Up/down controller	No cost	Specify <i>with up/down controller</i> .
	• 4 pre-set controller	+\$106	Specify <i>with 4 pre-set controller</i> .
	• Simple integrated controller	+\$106	Specify <i>with simple integrated controller</i> .
• 3 pre-set integrated controller	+\$106	Specify <i>with 3 pre-set integrated controller</i> .	
Cable Trough Type	• Cable trough	No cost	Specify <i>with cable trough</i> .
	• Support beam	-\$103	Specify <i>with support beam</i> .
Cable Trough Capacity	• Basic	No cost	Specify <i>with basic</i> .
	• Reduced (for Metal cable trough only)	No cost	Specify <i>with reduced</i> .
	• Expanded	+\$17	Specify <i>with expanded</i> .
Cable Trough Separator	For basic (with no hardwiring box) and expanded capacity only		
	• Separator	No cost	Specify <i>with separator</i> .
• No separator	No cost	Specify <i>with no separator</i> .	
Hardwire/ Software Utility Housing	• No hardwiring box	No cost	Specify <i>with no hardwiring box</i> .
	• Blank cutout hardwiring box	No cost	Specify <i>with blank cutout hardwiring box</i> .
	• 86 x 86 hardwiring box	+\$33	Specify <i>with 86 x 86 hardwiring box</i> .
	• 86 x 86 SCHUKO hardwiring	+\$33	Specify <i>with 86 x 86 SCHUKO hardwiring box</i> .
	• India hardwiring box	+\$33	Specify <i>with India hardwiring box</i> .
	• AH Meyer softwiring box	+\$33	Specify <i>with AH Meyer softwiring box</i> .
	• Australia CMS softwiring box	+\$33	Specify <i>with Australia CMS softwiring box</i> .

Specification Information

Description	Dimensions		Style Number	List Price (USD)
	D	W		
Fixed height	700 – 900	1200 – 1800	MGBDSFLRQB	\$1,405
Basic height	700 – 900	1200 – 1800	MGBDSBLRQB	\$2,201
Extended height	700 – 900	1200 – 1800	MGBDSELRQB	\$2,412
:	:	:	:	:

Base for 90° Bench

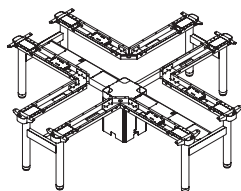

Standard Includes		Required to Specify	
<ul style="list-style-type: none"> • Electric height-adjustable sit-to-stand base: paint • Power cord length: 3 meters • 25mm glides • Attachment hardware • Up/down controller (not applicable for fixed height) • Plugs 		<ol style="list-style-type: none"> 1 Style number 2 Paint color number for legs base 3 Leg column (see below under Required Selections) 4 Cable trough type (see below under Required Selections) 5 Power solutions (see below under Required Selections) 6 Options, if selected (see below) 	
Required Selections		List Price	Required to Specify
Leg Column	<ul style="list-style-type: none"> • Rectangular • Round 	No cost No cost	Specify <i>with rectangular leg column</i> . Specify <i>with round leg column</i> .
Power Solutions	<p>Country</p> <ul style="list-style-type: none"> • Australia/New Zealand • Bangladesh • China • Hong Kong • India • Indonesia • Japan • Korea • Macau • Malaysia • Myanmar • Philippines • Singapore • Sri Lanka • Taiwan • Thailand • Vietnam 	No cost No cost No cost No cost No cost No cost No cost No cost No cost No cost No cost No cost No cost No cost No cost No cost No cost No cost	Specify <i>with Australia/New Zealand power</i> . Specify <i>with Bangladesh power</i> . Specify <i>with China power</i> . Specify <i>with Hong Kong power</i> . Specify <i>with India power</i> . Specify <i>with Indonesia power</i> . Specify <i>with Japan power</i> . Specify <i>with Korea power</i> . Specify <i>with Macau power</i> . Specify <i>with Malaysia power</i> . Specify <i>with Myanmar power</i> . Specify <i>with Philippines power</i> . Specify <i>with Singapore power</i> . Specify <i>with Sri Lanka power</i> . Specify <i>with Taiwan power</i> . Specify <i>with Thailand power</i> . Specify <i>with Vietnam power</i> .

► Options, continued on next page

► Options, continued from previous page

	Options	List Price	Required to Specify
Surface Materials	Upper Base		
	• Paint price group 1	No cost	Specify paint color number.
	• Paint price group 2	+\$27	Specify paint color number.
	• Paint price group 3	+\$37	Specify paint color number.
	Lower base		
	• Paint price group 1	No cost	Specify paint color number.
	• Paint price group 2	+\$27	Specify paint color number.
	• Paint price group 3	+\$37	Specify paint color number.
	Cable Trough		
	• Paint price group 1	No cost	Specify paint color number.
	• Paint price group 2	+\$12	Specify paint color number.
	• Paint price group 3	+\$16	Specify paint color number.
	Vertical riser cover		
	• Paint price group 1	No cost	Specify paint color number.
	• Paint price group 2	+\$12	Specify paint color number.
• Paint price group 3	+\$16	Specify paint color number.	
Controller	For basic and extended height only		
	• Up/down controller	No cost	Specify with up/down controller.
	• 4 pre-set controller	+\$215	Specify with 4 pre-set controller.
	• Simple integrated controller	No cost	Specify with simple integrated controller.
	• 3 pre-set integrated controller	+\$215	Specify with 3 pre-set integrated controller.
Cable Trough Quantity	Replace with support beam		
	• 0	-\$412	Specify with 0.
	• 1	-\$309	Specify with 1.
	• 2	-\$206	Specify with 2.
	• 3	-\$103	Specify with 3.
	• 4	No cost	Specify with 4.
Cable Trough Type	• PET	No cost	Specify with PET cable trough.
	• Metal	No cost	Specify with metal cable trough.
Vertical Riser Cover	• None	No cost	Specify with none.
	• Metal	+\$78	Specify with metal.
	• PET	+\$78	Specify with PET.
Cable Trough Capacity	• Basic	No cost	Specify with basic.
	• Reduced (for Metal cable trough only)	No cost	Specify with reduced.
Cable Trough Separator	For basic (with no hardwiring box) and expanded capacity only		
	• Separator	No cost	Specify with separator.
	• No separator	No cost	Specify with no separator.
Hardwire/ Software Utility Housing	• No hardwiring box	No cost	Specify with no hardwiring box.
	• Blank cutout hardwiring box	No cost	Specify with blank cutout hardwiring box.
	• 86 x 86 hardwiring box	+\$33	Specify with 86 x 86 hardwiring box.
	• 86 x 86 SCHUKO hardwiring	+\$33	Specify with 86 x 86 SCHUKO hardwiring box.
	• India hardwiring box	+\$33	Specify with India hardwiring box.
	• AH Meyer softwiring box	+\$33	Specify with AH Meyer softwiring box.
	• Australia CMS softwiring box	+\$33	Specify with Australia CMS softwiring box.

Specification Information

Description	Dimensions		Style Number	List Price (USD)
	D	W		
Fixed Height	Per worktop	1163	MGBDSFLLQB	\$2,419
Basic Height	Per worktop	1163	MGBDSBLLQB	\$3,859
Extended Height	Per worktop	1163	MGBDSELLQB	\$4,271
:	:	:	:	:

Base for 120° Bench – 2 Leg

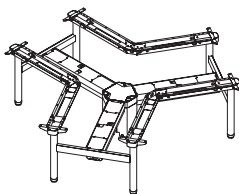

Standard Includes		Required to Specify	
<ul style="list-style-type: none"> • Electric height-adjustable sit-to-stand base: paint • Power cord length: 3 meters • 25mm glides • Attachment hardware • Up/down controller (not applicable for fixed height) • Plugs 		<ol style="list-style-type: none"> 1 Style number 2 Paint color number for legs base 3 Leg column (see below under Required Selections) 4 Cable trough type (see below under Required Selections) 5 Power solutions (see below under Required Selections) 6 Options, if selected (see below) 	
Required Selections		List Price	Required to Specify
Leg Column	<ul style="list-style-type: none"> • Rectangular • Round 	No cost No cost	Specify with rectangular leg column. Specify with round leg column.
For Top Depth	<ul style="list-style-type: none"> • D700 • D750 • D800 	No cost No cost No cost	Specify with D700 top depth. Specify with D750 top depth. Specify with D800 top depth.
For Top Width	<ul style="list-style-type: none"> • W1000 • W1200 	No cost No cost	Specify with W1000 top width. Specify with W1200 top width.
Power Solutions	<p>Country</p> <ul style="list-style-type: none"> • Australia/New Zealand • Bangladesh • China • Hong Kong • India • Indonesia • Japan • Korea • Macau • Malaysia • Myanmar • Philippines • Singapore • Sri Lanka • Taiwan • Thailand • Vietnam 	No cost No cost No cost No cost No cost No cost No cost No cost No cost No cost No cost No cost No cost No cost No cost No cost No cost No cost No cost	Specify with Australia/New Zealand power. Specify with Bangladesh power. Specify with China power. Specify with Hong Kong power. Specify with India power. Specify with Indonesia power. Specify with Japan power. Specify with Korea power. Specify with Macau power. Specify with Malaysia power. Specify with Myanmar power. Specify with Philippines power. Specify with Singapore power. Specify with Sri Lanka power. Specify with Taiwan power. Specify with Thailand power. Specify with Vietnam power.

► Options, continued on next page

► Options, continued from previous page

	Options	List Price	Required to Specify
Surface Materials	Upper Base		
	• Paint price group 1	No cost	Specify paint color number.
	• Paint price group 2	+\$27	Specify paint color number.
	• Paint price group 3	+\$37	Specify paint color number.
	Lower base		
	• Paint price group 1	No cost	Specify paint color number.
	• Paint price group 2	+\$27	Specify paint color number.
	• Paint price group 3	+\$37	Specify paint color number.
	Cable Trough		
	• Paint price group 1	No cost	Specify paint color number.
	• Paint price group 2	+\$12	Specify paint color number.
	• Paint price group 3	+\$16	Specify paint color number.
	Vertical riser cover		
	• Paint price group 1	No cost	Specify paint color number.
	• Paint price group 2	+\$12	Specify paint color number.
• Paint price group 3	+\$16	Specify paint color number.	
Controller	For basic and extended height only		
	• Up/down controller	No cost	Specify with up/down controller.
	• 4 pre-set controller	+\$161	Specify with 4 pre-set controller.
	• Simple integrated controller	No cost	Specify with simple integrated controller.
	• 3 pre-set integrated controller	+\$161	Specify with 3 pre-set integrated controller.
Cable Trough Quantity	Replace with support beam		
	• 0	-\$309	Specify with 0.
	• 1	-\$206	Specify with 1.
	• 2	-\$103	Specify with 2.
	• 3	No cost	Specify with 3.
Cable Trough Type	• PET	No cost	Specify with PET cable trough.
	• Metal	No cost	Specify with metal cable trough.
Vertical Riser Cover	• None	No cost	Specify with none.
	• Metal	+\$78	Specify with metal.
	• PET	+\$78	Specify with PET.
Cable Trough Capacity	• Basic	No cost	Specify with basic.
	• Reduced (for Metal cable trough only)	No cost	Specify with reduced.
	• Expanded	+\$17	Specify with expanded.
Cable Trough Separator	For basic (with no hardwiring box) and expanded capacity only		
	• Separator	No cost	Specify with separator.
	• No separator	No cost	Specify with no separator.
Hardwire/ Software Utility Housing	• No hardwiring box	No cost	Specify with no hardwiring box.
	• Blank cutout hardwiring box	No cost	Specify with blank cutout hardwiring box.
	• 86 x 86 hardwiring box	+\$33	Specify with 86 x 86 hardwiring box.
	• 86 x 86 SCHUKO hardwiring	+\$33	Specify with 86 x 86 SCHUKO hardwiring box.
	• India hardwiring box	+\$33	Specify with India hardwiring box.
	• AH Meyer softwiring box	+\$33	Specify with AH Meyer softwiring box.
	• Australia CMS softwiring box	+\$33	Specify with Australia CMS softwiring box.

Specification Information

Description	Dimensions		Style Number	List Price (USD)
	D	W		
Fixed Height	700 – 800	1000-1200	MGBDSFL2VQB	\$2,161
Basic Height	700 – 800	1000-1200	MGBDSBL2VQB	\$3,396
Extended Height	700 – 800	1000-1200	MGBDSEL2VQB	\$3,705
:	:	:	:	:

Base for 120° Bench – 3 Leg

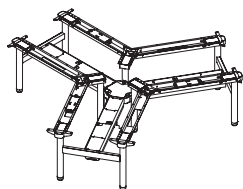

Standard

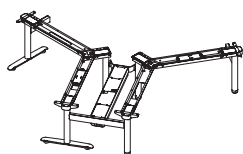

Egress

Standard Includes	Required to Specify
<ul style="list-style-type: none"> • Electric height-adjustable sit-to-stand base: paint • Power cord length: 3 meters • 25mm glides • Attachment hardware • Up/down controller (not applicable for fixed height) • Plugs 	<ol style="list-style-type: none"> 1 Style number 2 Paint color number for legs base 3 Leg column (see below under Required Selections) 4 Leg application (see below under Required Selections) 5 Cable trough type (see below under Required Selections) 6 Power solutions (see below under Required Selections) 7 Options, if selected (see below)

	Required Selections	List Price	Required to Specify
Leg Column	<ul style="list-style-type: none"> • Rectangular • Round 	No cost No cost	Specify with rectangular leg column. Specify with round leg column.
Leg Application	<ul style="list-style-type: none"> • Standard • Egress (extended) • Egress (basic) • Egress (fixed) 	No cost -\$1,235 -\$1,184 -\$618	Specify with standard. Specify with egress (extended). Specify with egress (basic). Specify with egress (fixed).
For Top Depth	<ul style="list-style-type: none"> • D700 • D750 • D800 	No cost No cost No cost	Specify with D700 top depth. Specify with D750 top depth. Specify with D800 top depth.
For Top Width	<ul style="list-style-type: none"> • W1400 • W1600 	No cost No cost	Specify with W1400 top width. Specify with W1600 top width.
Power Solutions	<p>Country</p> <ul style="list-style-type: none"> • Australia/New Zealand • Bangladesh • China • Hong Kong • India • Indonesia • Japan • Korea • Macau • Malaysia • Myanmar • Philippines • Singapore • Sri Lanka • Taiwan • Thailand • Vietnam 	No cost No cost No cost No cost No cost No cost No cost No cost No cost No cost No cost No cost No cost No cost No cost No cost No cost	Specify with Australia/New Zealand power. Specify with Bangladesh power. Specify with China power. Specify with Hong Kong power. Specify with India power. Specify with Indonesia power. Specify with Japan power. Specify with Korea power. Specify with Macau power. Specify with Malaysia power. Specify with Myanmar power. Specify with Philippines power. Specify with Singapore power. Specify with Sri Lanka power. Specify with Taiwan power. Specify with Thailand power. Specify with Vietnam power.

► Options, continued on next page

Migration SE Pro

► Options, continued from previous page

	Options	List Price	Required to Specify
Surface Materials	Upper Base		
	• Paint price group 1	No cost	Specify paint color number.
	• Paint price group 2	+\$27	Specify paint color number.
	• Paint price group 3	+\$37	Specify paint color number.
	Lower base		
	• Paint price group 1	No cost	Specify paint color number.
	• Paint price group 2	+\$27	Specify paint color number.
	• Paint price group 3	+\$37	Specify paint color number.
	Cable Trough		
	• Paint price group 1	No cost	Specify paint color number.
	• Paint price group 2	+\$12	Specify paint color number.
	• Paint price group 3	+\$16	Specify paint color number.
	Vertical riser cover		
	• Paint price group 1	No cost	Specify paint color number.
	• Paint price group 2	+\$12	Specify paint color number.
• Paint price group 3	+\$16	Specify paint color number.	
Controller	For basic and extended height only		
	• Up/down controller	No cost	Specify with up/down controller.
	• 4 pre-set controller	+\$161	Specify with 4 pre-set controller.
	• Simple integrated controller	No cost	Specify with simple integrated controller.
	• 3 pre-set integrated controller	+\$161	Specify with 3 pre-set integrated controller.
Cable Trough Quantity	Replace with support beam		
	• 0	-\$309	Specify with 0.
	• 1	-\$206	Specify with 1.
	• 2	-\$103	Specify with 2.
	• 3	No cost	Specify with 3.
Cable Trough Type	• PET	No cost	Specify with PET cable trough.
	• Metal	No cost	Specify with metal cable trough.
Vertical Riser Cover	• None	No cost	Specify with none.
	• Metal	+\$78	Specify with metal.
	• PET	+\$78	Specify with PET.
Cable Trough Capacity	• Basic	No cost	Specify with basic.
	• Reduced (for Metal cable trough only)	No cost	Specify with reduced.
	• Expanded	+\$17	Specify with expanded.
Cable Trough Separator	For basic (with no hardwiring box) and expanded capacity only		
	• Separator	No cost	Specify with separator.
	• No separator	No cost	Specify with no separator.
Hardwire/ Software Utility Housing	• No hardwiring box	No cost	Specify with no hardwiring box.
	• Blank cutout hardwiring box	No cost	Specify with blank cutout hardwiring box.
	• 86 x 86 hardwiring box	+\$33	Specify with 86 x 86 hardwiring box.
	• 86 x 86 SCHUKO hardwiring	+\$33	Specify with 86 x 86 SCHUKO hardwiring box.
	• India hardwiring box	+\$33	Specify with India hardwiring box.
	• AH Meyer softwiring box	+\$33	Specify with AH Meyer softwiring box.
	• Australia CMS softwiring box	+\$33	Specify with Australia CMS softwiring box.

Specification Information

• Description	• Dimensions		• Style Number	• List Price (USD)
	• D	• W		
Fixed Height	700 – 800	1400-1600	MGBDSFL3VQB	\$2,830
Basic Height	700 – 800	1400-1600	MGBDSBL3VQB	\$4,425
Extended Height	700 – 800	1400-1600	MGBDSEL3VQB	\$4,888
•	•	•	•	•

Base for Meeting Table

Base for Meeting Table

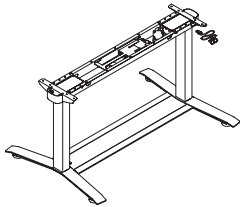

Standard Includes	Required to Specify
<ul style="list-style-type: none"> • Electric height-adjustable sit-to-stand base: paint • Power cord length: 3 meter • 25mm glides • Attachment hardware • Up/down controller (not applicable for fixed height) • Plugs 	<ol style="list-style-type: none"> 1 Style number 2 Paint color for base 3 Leg column (see below under Required Selections) 4 Top width (see below under Required Selections) 5 Power solutions (see below under Required Selections) 6 Options, if selected (see below)

	Required Selections	List Price	Required to Specify
Leg Column	<ul style="list-style-type: none"> • Rectangular • Round 	No cost No cost	Specify with <i>rectangular leg column</i> . Specify with <i>round leg column</i> .
For Top Width	<ul style="list-style-type: none"> • W1800 • W2200 	No cost No cost	Specify with <i>W1800 top width</i> . Specify with <i>W2200 top width</i> .
Power Solutions	<ul style="list-style-type: none"> • Australia/New Zealand • Bangladesh • China • Hong Kong • India • Indonesia • Japan • Korea • Macau • Malaysia • Myanmar • Philippines • Singapore • Sri Lanka • Taiwan • Thailand • Vietnam 	No cost No cost No cost No cost No cost No cost No cost No cost No cost No cost No cost No cost No cost No cost No cost No cost No cost No cost	Specify with <i>Australia/New Zealand power</i> . Specify with <i>Bangladesh power</i> . Specify with <i>China power</i> . Specify with <i>Hong Kong power</i> . Specify with <i>India power</i> . Specify with <i>Indonesia power</i> . Specify with <i>Japan power</i> . Specify with <i>Korea power</i> . Specify with <i>Macau power</i> . Specify with <i>Malaysia power</i> . Specify with <i>Myanmar power</i> . Specify with <i>Philippines power</i> . Specify with <i>Singapore power</i> . Specify with <i>Sri Lanka power</i> . Specify with <i>Taiwan power</i> . Specify with <i>Thailand power</i> . Specify with <i>Vietnam power</i> .

	Options	List Price	Required to Specify
Controller	<ul style="list-style-type: none"> • Up/down controller • 4 pre-set controller • Simple integrated controller • Double simple integrated controller • 3 pre-set integrated controller 	No cost +\$54 No cost +\$12 +\$54	Specify with <i>up/down controller</i> . Specify with <i>4 pre-set controller</i> . Specify with <i>simple integrated controller</i> . Specify with <i>double simple integrated controller</i> . Specify with <i>3 pre-set integrated controller</i> .
Surface Materials	<p>Upper base</p> <ul style="list-style-type: none"> • Paint price group 1 • Paint price group 2 • Paint price group 3 <p>Lower base</p> <ul style="list-style-type: none"> • Paint price group 1 • Paint price group 2 • Paint price group 3 	No cost +\$17 +\$23 No cost +\$17 +\$23	Specify paint color number. Specify paint color number. Specify paint color number. Specify paint color number. Specify paint color number. Specify paint color number. ▶ See <i>Surface Materials</i> , page 69
Footrest Cover	<ul style="list-style-type: none"> • Metal • Carpet 	No cost +\$16	Specify with <i>metal</i> . Specify with <i>carpet</i> .
Related Products	<ul style="list-style-type: none"> • Cable and power management 		▶ Page 60

Specification Information				
Height Range	Worksurface Dimensions D	W	Style Number	List Price (USD)
Basic Height	700 – 900	1200-1800	MGMBLMQB	\$1,300
Extended Height	700 – 900	1200-1800	MGMELMQB	\$1,400
:	:	:	:	:

Screens

Sarto Center Screen With Bracket

Standard Includes	Required to Specify
-------------------	---------------------

- Screen: fabric price group 1
- Connection brackets

- 1 Style number
- 2 Fabric color number
- 3 Options, if selected

Surface Materials	Options	List Price	Required to Specify
-------------------	---------	------------	---------------------

Surface Materials	Bracket paint		
	• Paint price group 1	No cost	Specify paint color number.
	• Paint price group 2	+\$7	Specify paint color number.
	• Paint price group 3	+\$9	Specify paint color number.
	Fabric		
	• Price group 1	No cost	Specify fabric color number.
	• Price group 2	+\$53	Specify fabric color number.
	Fabric Combo		
	• Combo	+\$99	Specify fabric color for combination screen—both sides.
	PET		
	• PET with no stripe	-\$48	Specify PET color number.
	• PET with stripe	+\$53	Specify PET color number.

Specification Information		
---------------------------	--	--

Style Number	Dimension H	Base Prices (USD)
		1000W : 1200W : 1400W : 1500W : 1600W : 1800W

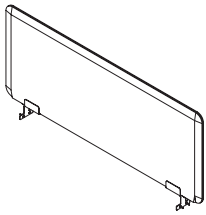

Sarto Center Screen for Dual Sided Bench

MGBDSCSB	1140 (624)	1220 (704)	1300 (784)	1400W	1500W	1600W	1800W
	\$367	\$388	\$431	\$377	\$398	\$441	\$400
	\$409	\$422	\$468	\$392	\$411	\$458	\$409
	\$436	\$431	\$510	\$400	\$422	\$468	\$409
				\$436	\$431	\$510	\$436

Specification Information		
---------------------------	--	--

Style Number	Dimension H	Base Prices (USD)
		1200W : 1400W : 1500W : 1600W : 1800W

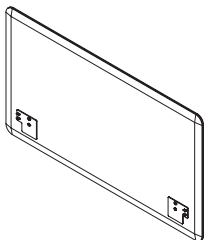

Sarto Fixed Single Sided Screen for Single Sided Bench

MGBSSCSB	1140 (875)	1220 (955)	1300 (1035)	1400W	1500W	1600W	1800W
	\$377	\$398	\$441	\$392	\$411	\$458	\$400
	\$409	\$422	\$468	\$392	\$411	\$458	\$409
	\$436	\$431	\$510	\$400	\$422	\$468	\$409
				\$436	\$431	\$510	\$436

Sarto Front Screen With Bracket

Standard Includes	Required to Specify
-------------------	---------------------

- | | |
|---|---|
| Standard Includes | Required to Specify |
| <ul style="list-style-type: none"> • Screen: fabric price group 1 • Connection brackets | <ul style="list-style-type: none"> 1 Style number 2 Fabric color number 3 Options, if selected |

Options	List Price	Required to Specify
---------	------------	---------------------

Options	List Price	Required to Specify
Surface Materials Bracket paint <ul style="list-style-type: none"> • Paint price group 1 • Paint price group 2 • Paint price group 3 	No cost +\$13 +\$17	Specify paint color number. Specify paint color number. Specify paint color number.
Fabric <ul style="list-style-type: none"> • Price group 1 • Price group 2 	No cost +\$106	Specify fabric color number. Specify fabric color number.
Fabric Combo <ul style="list-style-type: none"> • Combo 	+\$198	Specify fabric color for combination screen-both sides.
PET <ul style="list-style-type: none"> • PET with no stripe • PET with stripe 	-\$91 +\$101	Specify PET color number. Specify PET color number.

Specification Information		
---------------------------	--	--

Style Number	Dimension H	Base Prices (USD)
		1400W 1600W

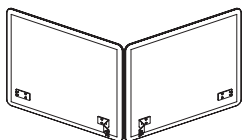

Sarto Front Screen for 120° Egress Bench

SSEFSSMIG120EBNCH	Dimension	List Price	Base Price
	1140 (880)	\$758	\$793
	1220 (960)	\$798	\$824
	1300 (1040)	\$886	\$948

Sarto Hanging Screen

Standard Includes	Required to Specify
-------------------	---------------------

- | | |
|---|---|
| Standard Includes | Required to Specify |
| <ul style="list-style-type: none"> Screen: fabric price group 1 Connection brackets | <ul style="list-style-type: none"> 1 Style number 2 Fabric color number 3 Options, if selected |

Options	List Price	Required to Specify
---------	------------	---------------------

Options	List Price	Required to Specify
Surface Materials Bracket paint <ul style="list-style-type: none"> Paint price group 1 Paint price group 2 Paint price group 3 	No cost +\$7 +\$9	Specify paint color number. Specify paint color number. Specify paint color number.
Fabric <ul style="list-style-type: none"> Price group 1 Price group 2 	No cost +\$53	Specify fabric color number. Specify fabric color number.
Fabric Combo <ul style="list-style-type: none"> Combo 	+\$99	Specify fabric color for combination screen—both sides.
PET <ul style="list-style-type: none"> PET with no stripe PET with stripe 	-\$48 +\$53	Specify PET color number. Specify PET color number.

Specification Information		
---------------------------	--	--

Style Number	Dimension H	Base Prices (USD)
		1200W 1400W 1500W 1600W 1800W

Sarto Hanging Screen for Desk

MGBHSCSB	665	\$488	\$506	\$515	\$527	\$552
	865	\$538	\$556	\$568	\$579	\$608
	:	:	:	:	:	:

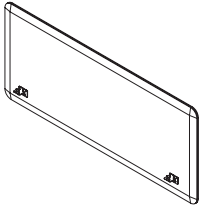

Migration SE Pro

Curved Screens

Standard Includes	Required to Specify
<ul style="list-style-type: none"> • Curved desk screen: fabric price group 1 • Fixed connection bracket: Merle 	<ol style="list-style-type: none"> 1 Style number 2 Desk Width 3 Handedness, if specifying single curved screen 4 Fabric color number for inside screen 5 Fabric color number for outside screen 6 Options, if selected <p>▶ See <i>Surface Materials</i>, page 69</p>

	Required Selections	List Price	Required to Specify
Handedness	Single curved screen		
	<ul style="list-style-type: none"> • LH privacy/RH modesty • RH privacy/LH modesty 	No cost No cost	Specify <i>with LH privacy/RH modesty</i> . Specify <i>with RH privacy/LH modesty</i> .

	Options	List Price	Required to Specify
Surface Materials	Curved Screen – Single Fabric for inside screen		
	• Fabric price group 1	No cost	Specify fabric color number.
	• Fabric price group 2	+\$27	Specify fabric color number.
	Fabric for outside screen		
	• Fabric price group 1	No cost	Specify fabric color number.
	• Fabric price group 2	+\$27	Specify fabric color number.
	Curved Screen – Pair Fabric for inside screen		
	• Fabric price group 1	No cost	Specify fabric color number.
	• Fabric price group 2	+\$54	Specify fabric color number.
	Fabric for outside screen		
• Fabric price group 1	No cost	Specify fabric color number.	
• Fabric price group 2	+\$54	Specify fabric color number.	
	Bracket – Single Screen		
	• Paint price group 1	No cost	Specify paint color number.
	• Paint price group 2	+\$7	Specify paint color number.
	Bracket – Pair of Screens		
	• Paint price group 1	No cost	Specify paint color number.
	• Paint price group 2	+\$7	Specify paint color number.

Specification Information

• Dimensions		• Style	• Base Prices (USD)				
H	D	Number	Desk Width				
			1200W	1400W	1500W	1600W	1800W

Flex Curved Screen—Single

475	13	FLXSCMG	\$281	\$308	\$320	\$340	\$362
•	•	•	•	•	•	•	•

Flex Curved Screen—Pair

475	13	FLXSMPMG	\$562	\$616	\$638	\$680	\$722
•	•	•	•	•	•	•	•

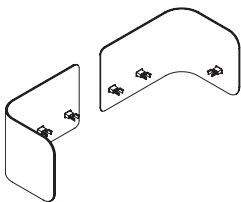

Infill Screen

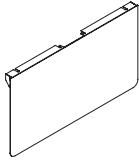

Standard Includes	Required to Specify
-------------------	---------------------

- | | |
|---|--|
| <ul style="list-style-type: none"> Infill screen | <ol style="list-style-type: none"> Style number Paint color number Options, if selected |
|---|--|

Options	List Price	Required to Specify
---------	------------	---------------------

Surface Materials	Base		
	• Paint price group 1	No cost	Specify paint color number.
	• Paint price group 2	+\$7	Specify paint color number.
	• Paint price group 3	+\$9	Specify paint color number.
	Bracket		
	• Paint price group 1	No cost	Specify paint color number.
• Paint price group 2	+\$7	Specify paint color number.	
• Paint price group 3	+\$9	Specify paint color number.	

Specification Information				
---------------------------	--	--	--	--

Style Number	Base Prices (USD)			
	700D	750D	800D	900D

Infill Screen				
---------------	--	--	--	--

MGBDSINCSB	\$83	\$89	\$94	\$104
:	:	:	:	:

Migration SE Pro

Cable Management Accessories

Upper Cable Tray

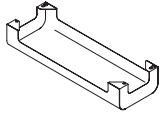

Simple

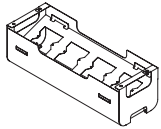

Metal

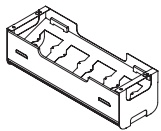

Metal-PET

Tip: Simple upper cable tray has no hardwiring.

Standard Includes		Required to Specify	
<ul style="list-style-type: none"> Cable tray: paint 		<ol style="list-style-type: none"> Style number Cable tray selections (see below) Paint color number PET color number, if Metal-PET is selected: <ul style="list-style-type: none"> BZ03 Dark Grey BZ11 Silver Options, if selected 	
Options		List Price	Required to Specify
Cable Tray	<ul style="list-style-type: none"> Simple Full metal Metal-PET 	No cost +\$32 +\$34	Specify with simple cable tray. Specify with full metal cable tray. Specify with metal-PET cable tray.
Surface Materials	<ul style="list-style-type: none"> Paint price group 1 Paint price group 2 Paint price group 3 	No cost +\$12 +\$16	Specify paint color number. Specify paint color number. Specify paint color number.
Center Cable Trough Power Housing	<ul style="list-style-type: none"> Softwire - AH Meyer 	+\$33	Specify with softwire AH Meyer.
Hardwire/Softwire Utility Housing	For full metal or metal-PET only <ul style="list-style-type: none"> No hardwiring box Blank cutout for hardwiring box 86 x 86 hardwiring box 86 x 86 SCHUKO hardwiring box India hardwiring box Australia CMS softwiring box 	No cost No cost +\$33 +\$33 +\$33 +\$33	Specify with no hardwiring box. Specify with blank cutout hardwiring box. Specify with 86 x 86 hardwiring box. Specify with 86 x 86 SCHUKO hardwiring box. Specify with India hardwiring box. Specify with Australia CMS softwiring box.

Specification Information	
Style Number	List Price (USD)
MGUCT	\$49

Cable Chain for Desk

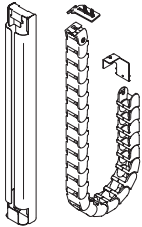

Standard Includes	Required to Specify
-------------------	---------------------

- Cable chain
- Cable housing

- 1 Style number
 - 2 Housing paint color number
 - 3 Leg column (see below under Required Selections)
 - 4 Height range (see below under Required Selections)
 - 5 Option, if selected (see below)
- ▶ See *Surface Materials*, page 69

Required Selections	List Price	Required to Specify
---------------------	------------	---------------------

Leg Column	• Round	No cost	Specify <i>with round column</i> .
	• Rectangular	No cost	Specify <i>with rectangular column</i> .

Height Range	• Basic	No cost	Specify <i>with basic height</i> .
	• Extended	No cost	Specify <i>with extended height</i> .

Options	List Price	Required to Specify
---------	------------	---------------------

Surface Materials	• Paint price group 1	No cost	Specify paint color number.
	• Paint price group 2	+\$12	Specify paint color number.
	• Paint price group 3	+\$16	Specify paint color number.

Specification Information		
Length	Style Number	List Price (USD)

1350	MGDVERT	\$64
------	----------------	------

Migration SE Pro

Cable Chain

Standard Includes	Required to Specify
-------------------	---------------------

- Cable chain
- Attachment hardware

- 1 Style number
- 2 Paint color number
- ▶ See *Surface Materials*, page 69

Specification Information		
Length	Style Number	List Price (USD)

Length	Style Number	List Price (USD)
--------	--------------	------------------

Cable Trough To Upper Tray (for Bench Only)

1200	MGBCTUT	\$58
⋮	⋮	⋮

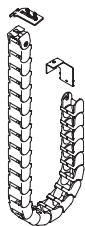

Floor Infeed

570	MGBCCFI	\$49
⋮	⋮	⋮



High Capacity Cable Chain (for Bench Only)

Standard Includes	Required to Specify
-------------------	---------------------

- High capacity cable chain
- Attachment hardware

- 1 Style number
- 2 Paint color number
- ▶ See *Surface Materials*, page 69

Specification Information		
Length	Style Number	List Price (USD)

Length	Style Number	List Price (USD)
--------	--------------	------------------

High Capacity Cable Chain (for Bench Only)

840	MGBHCTUT	\$75
⋮	⋮	⋮

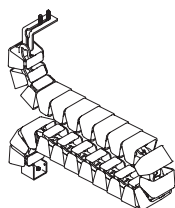

End Covers for Cable Trough (Set of 2)

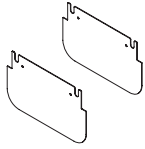

Standard Includes	Required to Specify
-------------------	---------------------

- End covers
- Attachment hardware

- 1 Style number
 - 2 Paint color number
 - 3 Option, if selected
- ▶ See *Surface Materials*, page 69

Options	List Price	Required to Specify
---------	------------	---------------------

Surface Materials	<ul style="list-style-type: none"> • Paint price group 1 • Paint price group 2 • Paint price group 3 	No cost +\$7 +\$9	Specify paint color number. Specify paint color number. Specify paint color number. ▶ See <i>Surface Materials</i> , page 69
--------------------------	---	-------------------------	---

Cable Trough Capacity	<ul style="list-style-type: none"> • Basic • Reduced • Expanded 	No cost No cost +\$7	Specify <i>with basic capacity</i> . Specify <i>with reduced capacity</i> . Specify <i>with expanded capacity</i> .
------------------------------	--	----------------------------	---

Specification Information		
Material	Style Number	List Price (USD)

Steel	MGBRAECT	\$31
:	:	:

Migration SE Pro

Connector for Cable Trough

Standard Includes		Required to Specify	
<ul style="list-style-type: none"> • Connector • Attachment hardware 		1 Style number 2 Paint color number 3 Option, if selected ▶ See <i>Surface Materials</i> , page 69	
Options		List Price	Required to Specify
Surface Materials	• Paint price group 1	No cost	Specify paint color number.
	• Paint price group 2	+\$7	Specify paint color number.
	• Paint price group 3	+\$9	Specify paint color number. ▶ See <i>Surface Materials</i> , page 69
Cable Trough Capacity	• Basic	No cost	Specify <i>with basic capacity</i> .
	• Reduced	No cost	Specify <i>with reduced capacity</i> .
	• Expanded	+\$12	Specify <i>with expanded capacity</i> .
Egress Connector Handedness	For basic and expanded capacity only		
	• Left	No cost	Specify <i>with left hand</i> .
	• Right	No cost	Specify <i>with right hand</i> .

Specification Information		
Material	Style Number	List Price (USD)

Connector for Cable Trough (for Single & Dual Sided Bench)

Steel	MGBRACCTR	\$31
-------	------------------	------

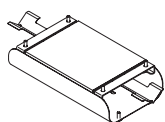

Connector for Cable Trough (for Egress)

Steel	MGBRACSTR	\$31
-------	------------------	------

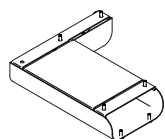

Vertical Riser

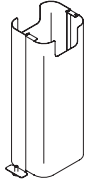

Standard Includes	Required to Specify
-------------------	---------------------

- Cable riser
- Attachment hardware

- 1 Style number
 - 2 Paint color number
 - 3 Option, if selected
- ▶ See *Surface Materials*, page 69

Options	List Price	Required to Specify
---------	------------	---------------------

Surface Materials	• Paint price group 1	No cost	Specify paint color number.
	• Paint price group 2	+\$12	Specify paint color number.
	• Paint price group 3	+\$16	Specify paint color number. ▶ See <i>Surface Materials</i> , page 69

Cable Capacity	• Basic	No cost	Specify <i>with basic capacity</i> .
	• Expanded	+\$12	Specify <i>with expanded capacity</i> .

Specification Information		
Material	Style Number	List Price (USD)

Steel	MGBACRS	\$60
•	•	•
•	•	•

Migration SE Pro

Cable Management Box Power Outlet



Tip: Applicable for 90 degree Bench AH Meyer cutout.



Standard Includes	Required to Specify
<ul style="list-style-type: none"> Technology unit Note : Starter cable not included 	Style number

Specification Information

Country	Style Number	List Price (USD)
---------	--------------	------------------

3 Powers

Australia/ New Zealand	MFUSTPPPP1C	\$153
Hong Kong/ Singapore/ Malaysia	MFUSTPPPP2C	\$109
Thailand	MFUSTPPPP3C	\$153
China	MFUSTPPPP4C	\$153
India	MFUSTPPPP5C	\$118
Japan	MFUSTPPPP6C	\$113
Indonesia/ Korea	MFUSTPPPP7C	\$151

Starter Cable



Standard Includes	Required to Specify
<ul style="list-style-type: none"> Starter cable for technology unit 	Style number

Specification Information

Country	Style Number	List Price (USD)
---------	--------------	------------------

3 Meter

Australia	VPSCBL30S1A	\$104
Hong Kong	VPSCBL30S2A	\$69
Singapore	VPSCBL30S2B	\$69
Malaysia	VPSCBL30S2C	\$69
Thailand	VPSCBL30S3	\$46
China	VPSCBL30S4	\$50
India	VPSCBL30S5	\$59
Japan	VPSCBL30S6	\$63
Korea	VPSCBL30S7	\$50

5 Meter

Australia	VPSCBL50S1A	\$125
-----------	--------------------	-------

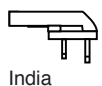
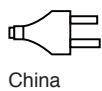

Surface Materials

Surface Materials Matrix	70
Surface Materials	72

Surface Materials Matrix

Color Logic

- Components in the same segment (upper/lower) must use the same finishes.
- We strongly recommend components in trims segment use the same finishes.

		Lower Leg Column	Cable Trough	Cross Beam	Upper Leg Column	Cantilever	Cantilever Beam	Upper Cable Tray	Upper Cable Tray Cover	Cable Trough End Cover	Bench Cable Trough Connector	Vertical Riser	Cable Trough Cover	Worksurface Top	Worksurface Edge	Screen
		Lower Segment			Upper Segment			Trims								
Metal Paint																
Price Group 1																
NI	Nickel	•	•	•	•	•	•	•	•	•	•	•	•			
7241	Arctic White	•	•	•	•	•	•	•	•*	•	•	•	•			
7360	Merle	•	•	•	•	•	•	•	•*	•	•	•	•			
7207	Black	•	•	•	•	•	•	•	•*	•	•	•	•			
4799	Platinum	•	•	•	•	•	•	•	•	•	•	•	•			
Price Group 2																
4CZ1	Aubergine	•	•	•	•	•	•	•	•	•	•	•	•			
4CZ2	Peacock	•	•	•	•	•	•	•	•	•	•	•	•			
4CZ3	Jungle	•	•	•	•	•	•	•	•	•	•	•	•			
4CZ4	Merlot	•	•	•	•	•	•	•	•	•	•	•	•			
4CZ5	Honey	•	•	•	•	•	•	•	•	•	•	•	•			
4CZ6	Lagoon	•	•	•	•	•	•	•	•	•	•	•	•			
4CZ7	Saffron	•	•	•	•	•	•	•	•	•	•	•	•			
1ATB	Cloud#	•	•	•	•	•	•	•	•	•	•	•	•			
1ATH	Olivine	•	•	•	•	•	•	•	•	•	•	•	•			
1ATJ	Sea Salt	•	•	•	•	•	•	•	•	•	•	•	•			
1ATK	Citrine	•	•	•	•	•	•	•	•	•	•	•	•			
1ATR	Blush	•	•	•	•	•	•	•	•	•	•	•	•			
4EE9	Electric Indigo	•	•	•	•	•	•	•	•	•	•	•	•			
Price Group 3																
4B20	Obsidian	•	•	•	•	•	•	•	•	•	•	•	•			
4B22	Matte Bronze	•	•	•	•	•	•	•	•	•	•	•	•			
4B23	Burnished Bronze	•	•	•	•	•	•	•	•	•	•	•	•			
4B24	Night Bronze	•	•	•	•	•	•	•	•	•	•	•	•			
4B25	Matte Copper	•	•	•	•	•	•	•	•	•	•	•	•			

Due to light reflecting from different angles, proximity to light source, differences in color of light source and difference in surrounding surfaces can cause the illusion of variations in color and shading.

* If textured paints are selected as the base finish, the inner leg column finishes are automatically converted to its relative glossy paint finish as per table below:

Paint Name	Textured Paint	Smooth Paint
Arctic White	7241	4140
Merle	7360	4243
Black	7207	BK

	Lower Leg Column	Cable Trough	Cross Beam	Upper Leg Column	Cantilever	Cantilever Beam	Upper Cable Tray	Upper Cable Tray Cover	Cable Trough End Cover	Bench Cable Trough Connector	Vertical Riser	Cable Trough Cover	Worksurface Top	Worksurface Edge	Screen
	Lower Segment			Upper Segment			Trims								
Low Pressure Laminate															
Solid Laminate															
AW01 Arctic White													•	•	
2L83 Seagull													•	•	
2LMG Merle													•	•	
Woodgrain Laminate															
160 Maple													•	•	
25L8 Clear Walnut													•	•	
24L0 Graphite Walnut													•	•	
2LAT Acacia													•	•	
2LWE Warm Elm													•	•	
2LGO Grey Oak													•	•	
PET															
BZ03 Dark Grey							•					•			
BZ11 Silver							•					•			•
BZ10 Ivy Green															•
BZ25 Sky Blue															•
Fabric for Screens															
Price Group 1															
Omni-R															•
Otto															•
Price Group 2															
Cogent Connect															•
Era															•
Medley															•
Price Group 3															
Gamut															•

Surface Materials

Fabric

Applies to:
• Screen

Price Group 1

Omni-R

J501 Ebony
J502 Crimson
J506 Sapphire
J507 Ink Blue
J508 Rhino
J509 Cocoa
J513 Azure Blue
J515 Hydrangea
J517 Cork
J518 Maize
J521 Cloud
J535 Coconut
J537 Tangerine
J538 Scarlet
J541 Blue Jay
J543 Wasabi
J544 Nickel
J547 Malt

Otto

K601 Peacock
K602 Lizard
K603 Olive
K604 Grass
K605 Honey
K606 Coral
K607 Saffron
K608 Merlot
K609 Aubergine
K610 Lagoon
K611 Bluestone
K612 Smoke
K613 Iron
K614 Ash
K615 Charcoal

Price Group 2

Cogent Connect*

5S15 Coconut
5S16 Turmeric/Honey
5S17 Tangerine
5S18 Scarlet
5S19 Concord
5S21 Blue Jay
5S23 Wasabi
5S24 Nickel
5S25 Graphite
5S26 Licorice
5S27 Malt
5S28 Root Beer
5S93 Blue Print
5S94 Lizard/Jungle
5S95 Sailor
5S96 Quicksilver
5S99 Lipstick/Merlot
5SD0 Royal Blue
5SD1 Aubergine
5SD2 Peacock
5SD3 Lagoon
5SD4 Saffron
5SD5 Citrine
5SD6 Rose Quartz
5SD7 Sea Salt
5SF3 Storm Cloud
5SF4 Olivine

Price Group 2

Medley

60003 Grey
60004 Pepper
60167 Grey Brown
60999 Pepper Black
61002 Beige
61003 Chamois
61004 Mocha
62002 Mustard Yellow
63017 Orange Mix
64019 Red
64123 Cherry Red
64125 Dark Pink
65012 Purple
65086 Dark Purple
66007 Blue Jean
66008 Light Grey
66010 Blue
66144 Denim
66145 Blue Purple
67002 Khaki
67006 Sky Blue
67053 Water Blue
67054 Dark Green
68002 Apple Green
68005 Khaki Green

*Cogent Connect not applicable only for different SideA/B screen fabrics. If same fabric on both sides, user can select Cogent Connect.

Price Group 2

Era

5ER0 Cobalt
5ER2 Blue Nickel
5ER3 Pistachio
5ER6 Truffle
5ER7 Saffron
5ER8 Pink Lemonade
5ER9 Onyx
5ES0 Scarlet
5ES3 Persimmon
5ES4 Sprout
5ES5 Blue Mint
5ES7 Night Owl
5ET1 Peach
5ET2 Cherry
5ET3 Fresh Green
5ET4 Jade
5ET5 Sky
5ET6 Cloud
5ET7 Ocean
5ET8 Stone
5ET9 Slate
5EU1 Pink
5EU2 Electric Indigo
5EU3 Green Citrine
5EU4 Storm Cloud

Price Group 2

Stencil

P455 Midnight
P456 Mulberry
P457 Cracked Pepper
P458 Denim
P459 Chartreuse
P460 Bittersweet
P461 Mauvelous
P462 Bermuda
P463 Concrete
P464 Orchid
P465 Parchment
P466 Silk
P467 Sea Salt
P468 Honeydew
P469 Sepia

PET

Applies to:
• Screen

BZ03 Dark Grey
BZ11 Silver
BZ47 Cloud
1902 Flax
1904 Sea Salt
1907 Denim

**PET colors may vary from different batches due to fibre mix and lay up which is an inherent feature of this material.*

Thread Color

Define Thread Color

If the user selects different fabrics for Side A/ Side B, Pcon will allow to choose the thread color contrast.

Please choose thread match to Side A / or Side B fabric. Please note that thread match is only possible for 1 side. The other side will be contrast by the set design language for the screen.