

OSIER

Poytec Steccawood prefinished half round batten over lay pedestal base table with 25mm thick melamine top

MTO

Lead time: 4-5 weeks

Origin: NSW

Available as a supply and fit item or supply only



Product tear sheet

TOP FINISHES:

Cost effective: Laminex core commercial melamine range, 25mm thick with square ABS or shark nose edge detail, black or white under bevel

Mid-range: Polytec Ravine or Woodmatt range, 25mm thick with square ABS or shark nose edge detail, black or white under bevel

BASE FINISH:

Half round 24 x 24 x 48mm batten over lay in Polytec readily available finishes:

Without minimal order quantity

- raw to be painted Dulux colour, polyurethane sealed
- Black Woodmatt
- Florentine Walnut Woodmatt
- Natural Oak Ravine
- Notaiio Walnut Woodmatt
- Prime Oak Woodmatt

Order minimum will apply to

- Angora Oak Woodmatt
- Bianco Woodmatt
- Distressed Wood Ravine
- Empire Oak Woodmatt
- Maison Oak Ravine
- Nordic Oak Woodmatt
- Perugian Walnut Woodmatt

With white or black 67mm H toe space and black adjustable glides

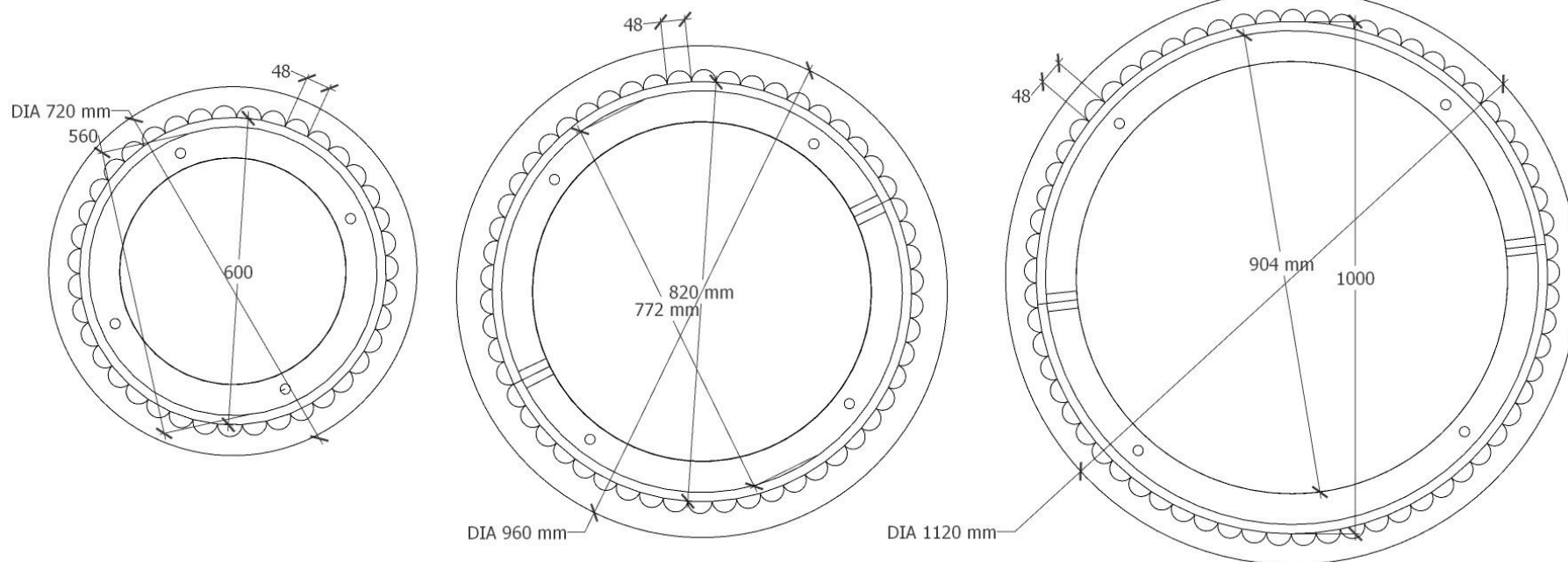

Product tear sheet

CONFIGURATIONS:

Proposed sizes have been material usage optimised, custom also available on request

720mm H

BASE: single 600mm dia.

TOP: 1000-1200mm dia.

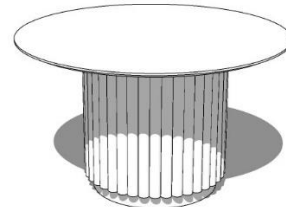

1010mm H

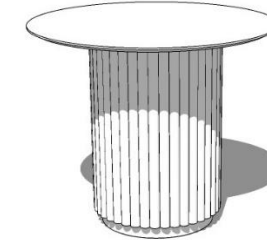

BASE: double 600mm dia.

TOP: 1000-1200mm x 1700-2400mm oblong.

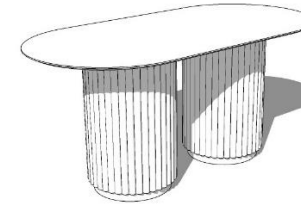
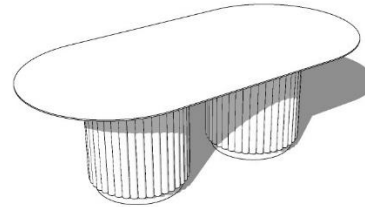

BASE: single 800mm dia.

TOP: 1250-1600mm dia.

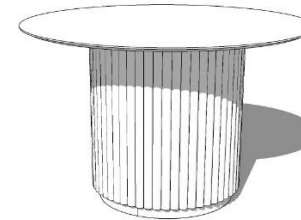
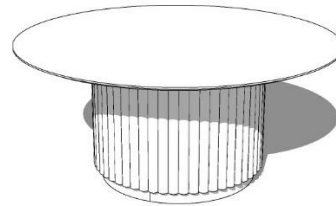

BASE: single 1000mm dia.

TOP: 1400-1800mm dia.

