

HoFFtable

education training hospitality meeting conference



HoFFTABLE FLIP

TRAINING TABLE

The HoFF flip table series is an architecturally designed and inspired flip top stacking table line that allows one to quickly set up or rearrange multiple room configurations with a single handed operation.

The HoFF frame and its adaptable width frame design allows for individual user choice. The main frame starts at W1200mm and can extend up to a maximum W1800mm frame width.

Base Options:

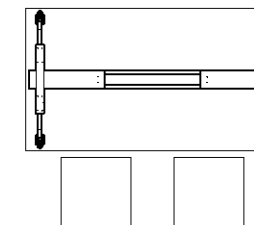

Full base provides ample cross-table seating for theater-style training.

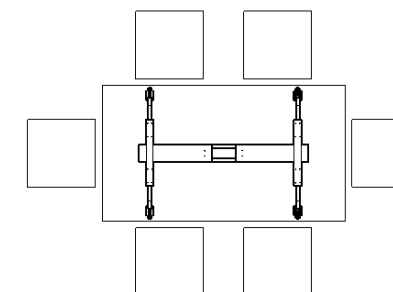

Variable width frame provides option for inset position for maximum perimeter seating.



HoFFTABLE FLIP
SOFT-CLOSE MECHANISM



*Functional mobility via heavy-duty
Dia65mm braked castors*



*Simple single handed control releases
heavy duty flip mechanism*



Proprietary soft-close flip mechanism.



*The flip tables design allows for high
density nesting storage capabilities*



LEARNING

Where knowledge is put collectively through education or experience



DISCUSSION

Where innovation and creative ideas are brainstormed



MEETING

Where decision and sharing of ideas takes place

HoFFTABLE FLIP

VERSATILITY

HoFF tables are designed to give businesses the ability to quickly and easily configure a room to meet the demands of the office from any user group at any time of the working day. Adaptable, Sustainable, Ready-to-work and Smarter design/thinking...these are the core ideas and values behind the HoFF table series. They allow businesses to fully utilise the space and environment around them with multiple workspace scenarios to benefit each working user group.



Perfect for all training/learning environments the HoFF Flip table folds and nests in clusters so you can adapt a space into a multi-function environment.

HoFFTABLE FLIP INTEGRATION

The HoFF flip table frame has been designed to maximise integration within any environment. With the ability to house cable management internally the HoFF table keeps its mobility and versatility at all times.

Power and data can be permanently housed within the table frame allowing a 'plug-n-play' flexibility when having to change around training or meeting room configurations.

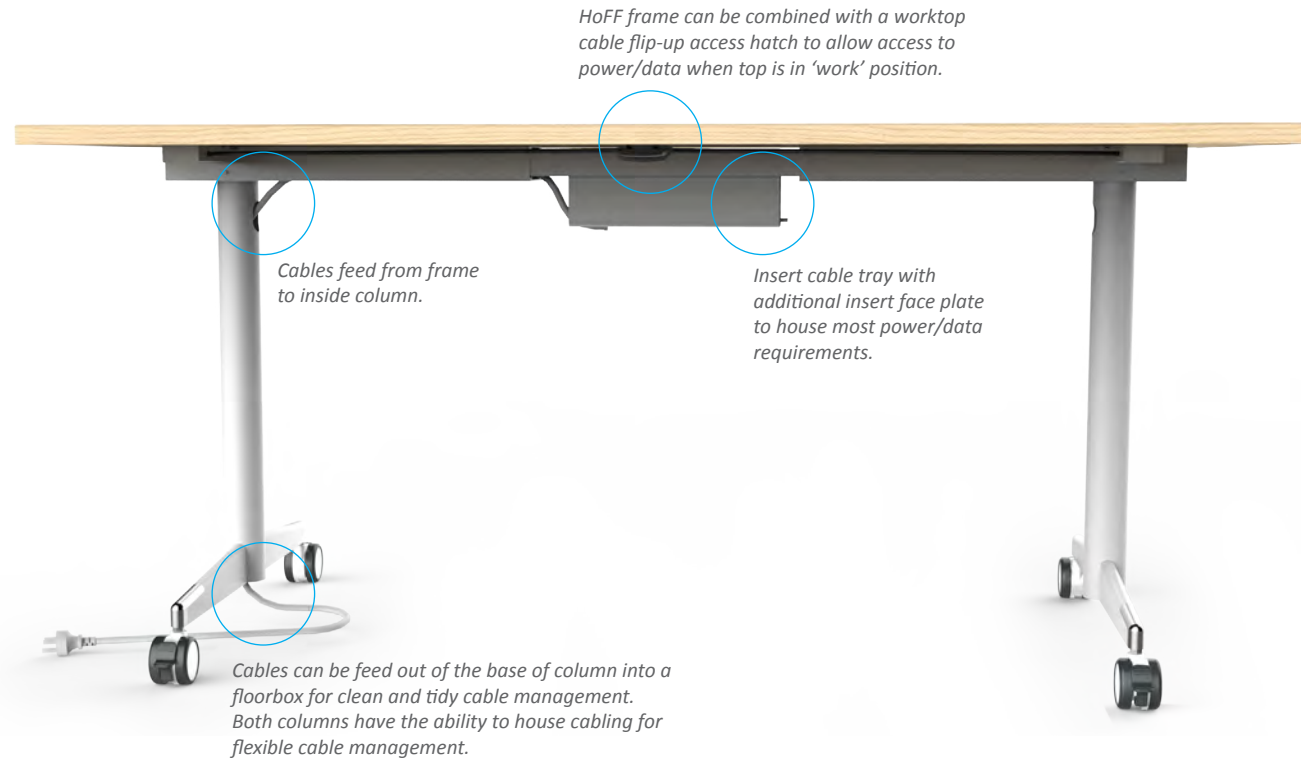

Cabling and power/data can be accessed with worktop in both 'work' or flipped up 'storage' position.

Integrated cable flip hatch gives access to the cable tray insert below housing client own power and data specifications. Cable Management feeds through the HoFF framework columns creating a clean and tidy integrated setup.

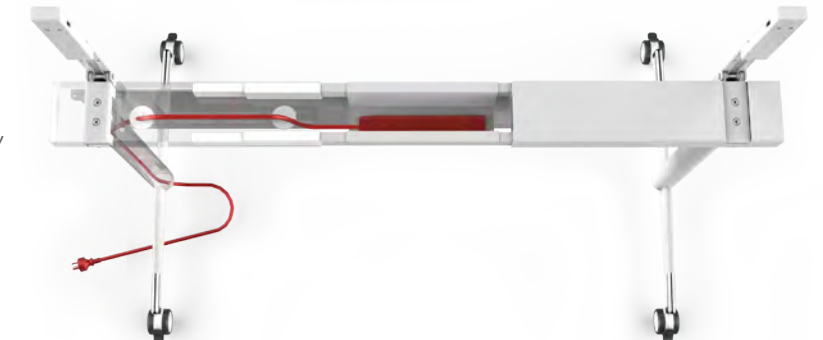

HoFFTABLE FIXED

MOBILE DISCUSSION TABLE

As well as the HoFF Rectangular Flip range there is also a Discussion Table that uses the HoFF X-foot 4 star base with castors and a Round worktop size from Dia500 - 900mm to create a multi-functional round or square touchdown meeting point for any environment.



Round or Square mobile meeting tables with a X-foot 4star base incl. braked duo-tone castors.

HoFFTABLE FIXED

MEETING

HoFF fixed table series is a family of stationary meeting and boardroom tables with 4-star and meeting & conference bases allowing for a variety of functional configurations from D600mm round occasional tables up to full-length W6000 x D1200mm boardroom tables with integrated wire management.

The HoFF table system has been specifically designed so that a cohesive family aesthetic across a wide range of table configurations is available.



Round or Square Meeting Tables with a X-foot 4star Fixed base and 10mm Adjustable glides.

HoFFTABLE FIXED

CONFERENCE

With the HoFF adaptable frame large scale conference tables are possible with either straight T-foot or 135deg angled V-foot leg configurations.

Integration of cable flip-up hatches, cable grommets or various AV applications can be catered for within the framework and worktops.

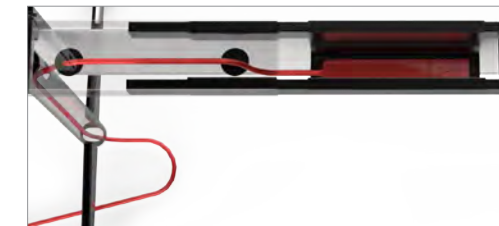

Integrated cable flip hatch gives access to the cable tray insert below housing client own power and data specifications.



Cable Management feed through the HoFF framework columns creates a clean and crisp integrated setup.

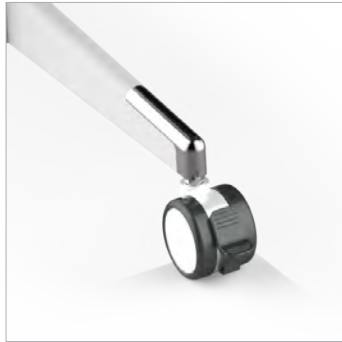

Heavy Duty 65mm Braked Castor



30mm Glide



Soft-close Flip Mechanism



Flip Training Table

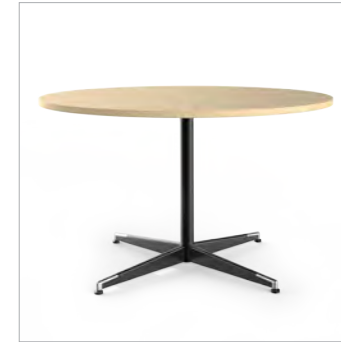

Fixed Round Meeting Table - X-foot

HoFFTABLE DETAILS MATTER

The HoFF table series has been designed with the environment in mind. HoFF components have been carefully selected and produced for their green sustainability credentials to ensure that the HoFF table bases can be 100% disassembled and ready for recycling when the time arises.



Fixed Modesty Panel



Adjustable Width Beam
W1200 - W1800mm



Nesting Cluster Ability



Fixed Meeting Table - T or V-foot



Fixed Conference Table - T or V-foot



Cable Tray Insert

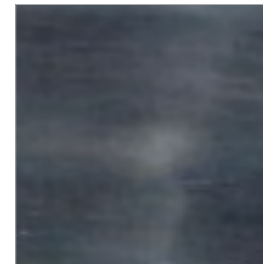

Table Connector



Mobile Discussion Table

STANDARD FINISHES



Chrome

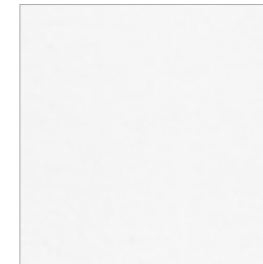

White Metallic Texture

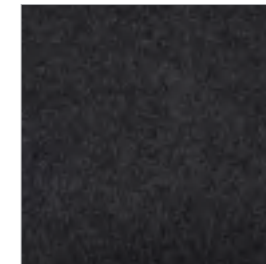

Black Metallic Texture

MOBILE DISCUSSION TABLE SIZES

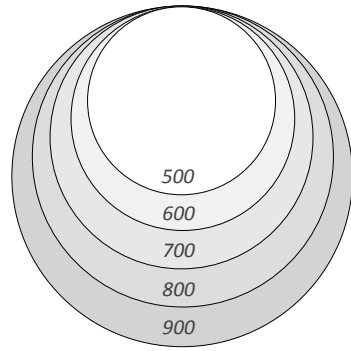

RECTANGULAR TABLE SIZES

	1200	1400	1600	1800	2000
D500					
D600					
D750					
D800					
D900					
D1000					

*An cable tray insert for rectangle tables is available from widths of W1500 - 2000mm.

TRAPEZOID TABLE SIZES

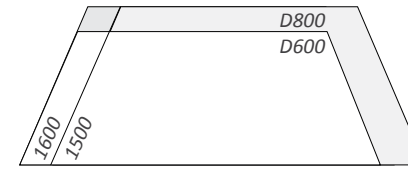

SEMI-CIRCLE 'D' TABLE SIZES

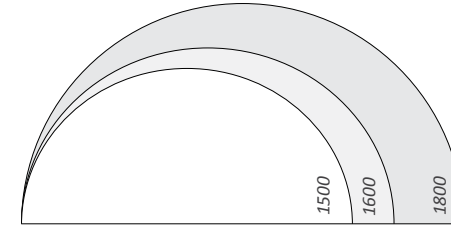
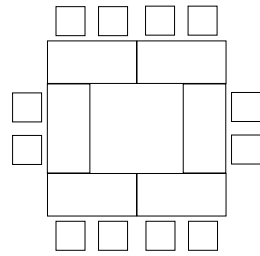
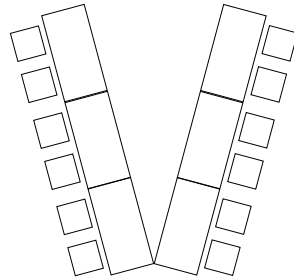

TABLE CONFIGURATIONS

Conferencing



Presentation



Seminar U-shape

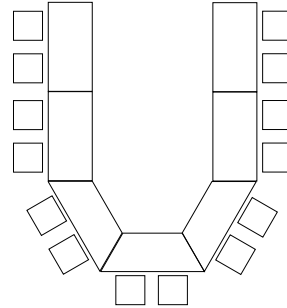

Semi-Circle Round

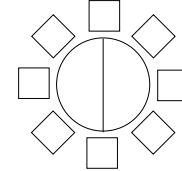

Semi-Circle Oval

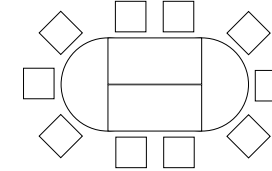

Row

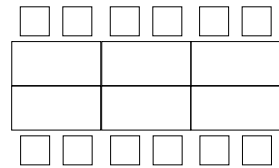

Training

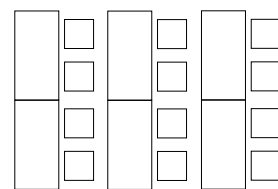

Seminar Training

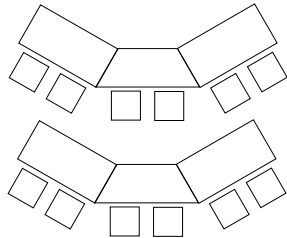

Conference Oval

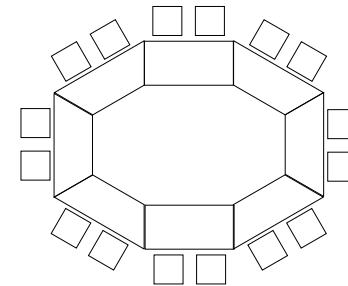

Conference O-shape

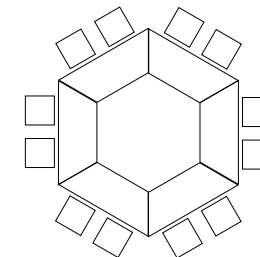

HoFFTABLE FLIP STATEMENT OF LINE

The HoFF frame and its adaptable width frame design allows for individual user choice. The main frame starts at W1200mm and can extend full width by 600mm up to a maximum W1800mm configuration, an alternate beam option is also available that starts at W1800mm and extends to W2400mm.

A cable tray insert is available from extended widths of W1500 - 2000mm.

HoFF Frame Width Extension

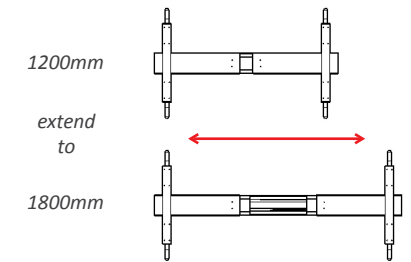

Nested Rectangle Table

- based on 5no. W1600 x D800mm tables.

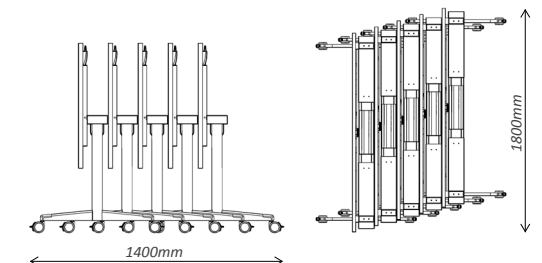

HoFFTABLE FIXED

STATEMENT OF LINE

RECTANGULAR MEETING TABLE SIZES

	1200	1400	1600	1800	2000	2200	2400
D700							
D800							
D900							
D1000							
D1100							
D1200							

*An cable tray insert for rectangle tables is available from widths of W1500 - 2400mm.

FRAME WIDTH EXTENSIONS

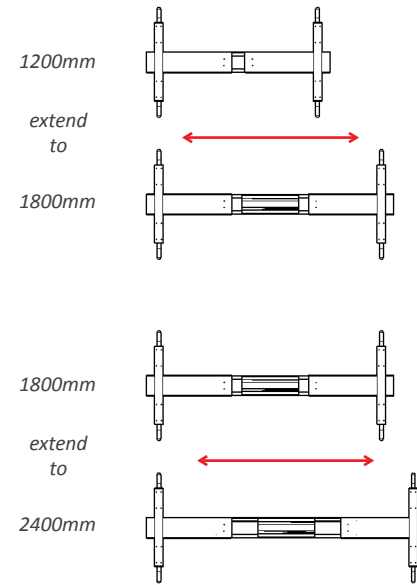

HoFF FOOT SIZES

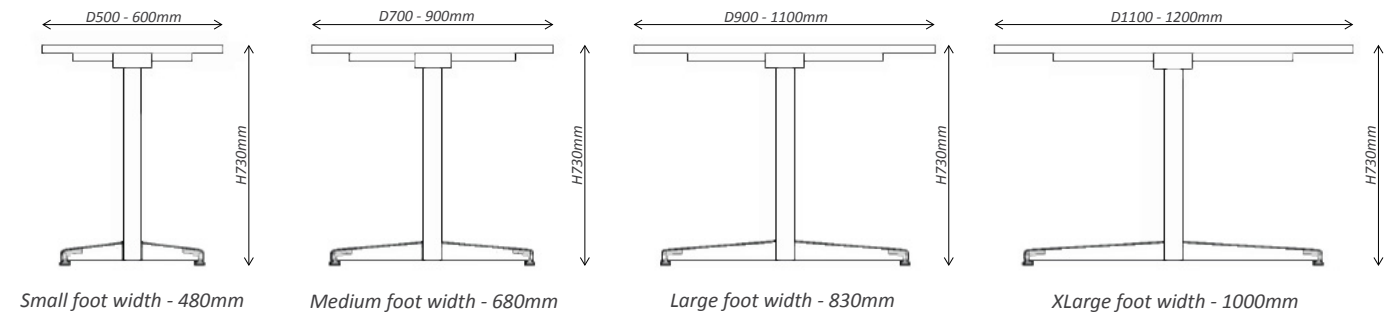

Column Cable Entry Access



Column Cable Exit Access



Cable Tray Insert

RECTANGULAR CONFERENCE TABLE SIZES

	3000	3200	3400	3600	3800	4000	4200	4400	4800	5400	6000
D800											
D900											
D1000											
D1100											
D1200											

HoFF FOOT DETAILS



HoFF T-foot configuration



HoFF V-foot configuration

ROUND TABLE SIZES

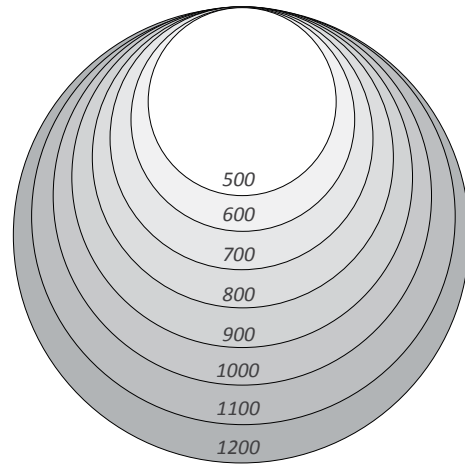

HoFF FOOT DETAIL



HoFF X-foot configuration

ROUND TABLE HEIGHTS

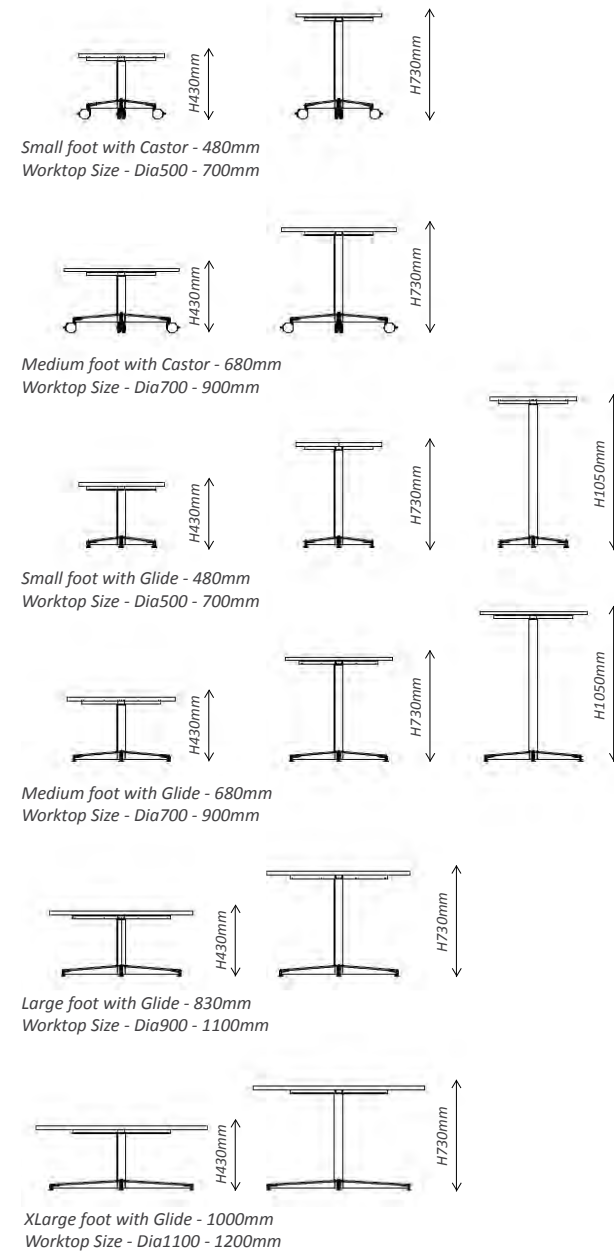

XCHANGE

www.xchangedesign.com

Australia

xchange design Australia Pty Ltd

PO Box 44

St Ives NSW 2075

Australia

contact@xchangedesign.com.au

Switzerland

xchange design GmbH

Schartenstrasse 3

CH-5400 Baden

Switzerland

contact@xchangedesign.ch

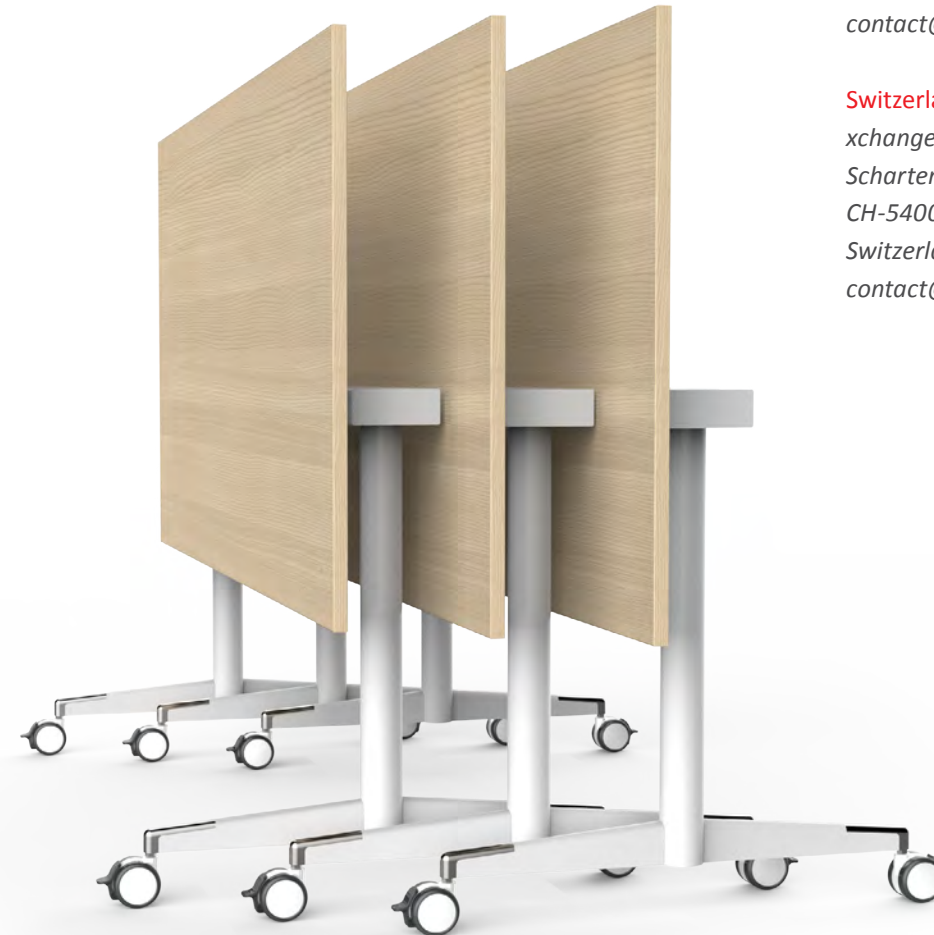

FURNITURE IS ARCHITECTURE ON A DIFFERENT SCALE



Melbourne | Canberra | Sydney | Brisbane | Perth | Adelaide | Hobart | Ulverstone

