

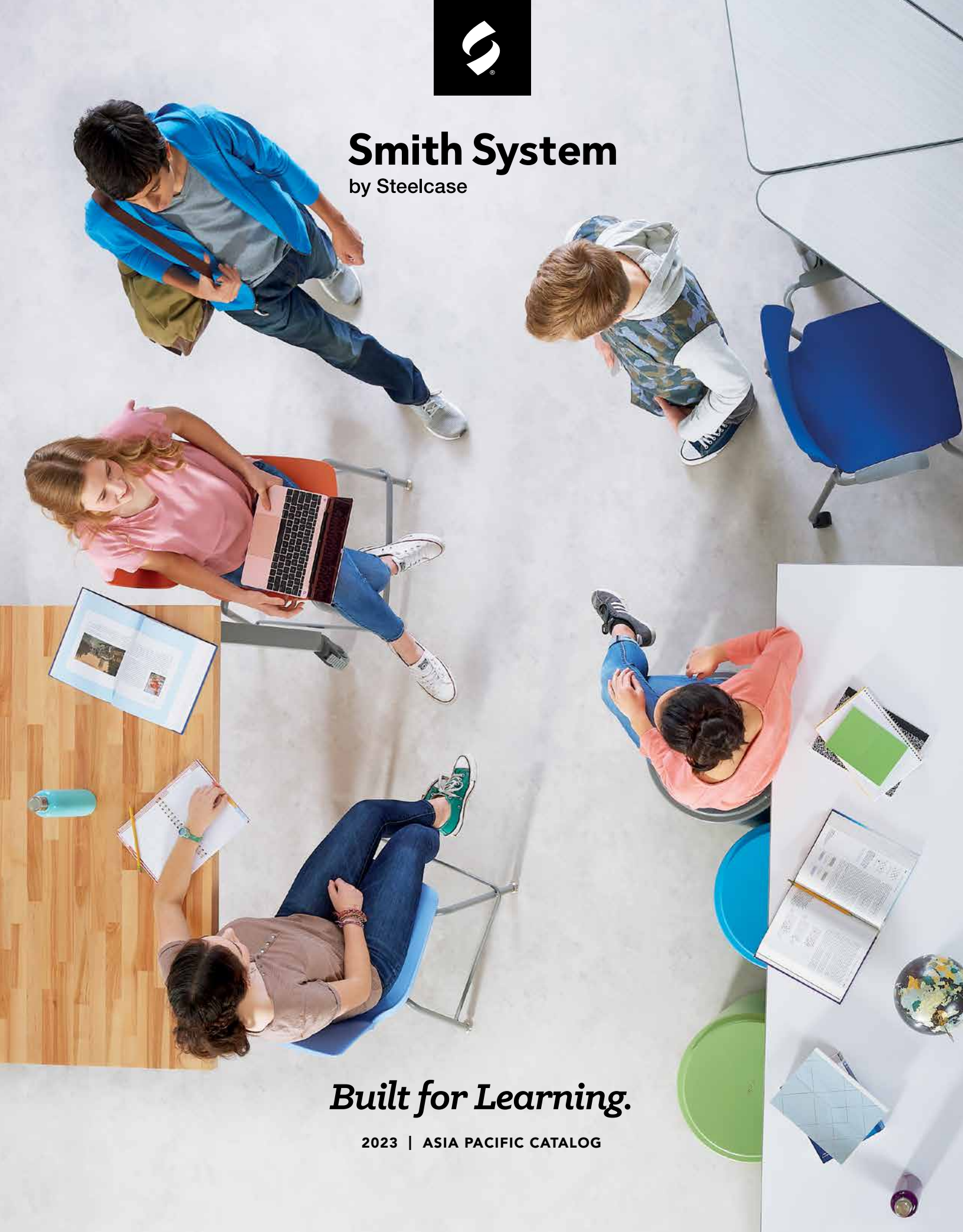

Smith System

by Steelcase



Built for Learning.

2023 | ASIA PACIFIC CATALOG

**Learning happens in
the spaces that
inspire it.**



Table of Contents

6

About Smith System

- 06 Welcome
- 08 Designed to Deliver
- 12 Before You Begin

14

What's New?

- 16 Numbers™ Cantilever
- 18 Numbers High Range Desk & Stool

20

Learning Spaces

- 22 Esports
 - 24 VR Labs
 - 26 Informal Spaces
 - 28 Makerspaces
 - 30 Tech Spaces
 - 32 Learning Commons
 - 34 Art Classrooms
-

36

Seating

- 40 Numbers™
- 44 Flavors®
- 50 Oodle®
- 56 Flowform™

66

Desks & Tables

- 70 Numbers™
- 76 Flowform™
- 83 Interchange®
- 108 Elemental®
- 112 Silhouette®
- 124 Silhouette® Sit+Stand
- 128 Planner®

140

Storage

- 142 Flowform™ Storage
- 146 Cascade® Storage
- 152 Towers
- 153 Cabinets
- 154 Mini Cases
- 155 Whiteboard



THE SMITH BLOG
www.smithsystem.com/smithfiles

Smith System
by Steelcase

The following, in word, stylized and design forms, are trademarks of Smith System Manufacturing Company: 3-2-1 Desk, Acrobat, Cascade, Chat, Elemental, Flavors, Flexline, Furniture for Inspired Learning, Groove, Huddle, In2it, Interchange, Interchange Diamond, Interchange Open Front Wing, Oodle, Planner, Plato, Sequence, Silhouette, Smith System, the Smith System "Swirl" Logo, Theorem and UXL (UXL Nest & Fold and Sit+Stand). Trespa and TopLab Plus are trademarks of Trespa International B.V.

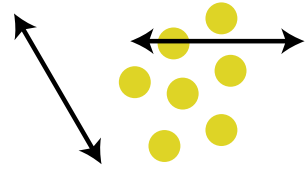

Welcome to Smith System.

We design and build furniture exclusively for learning environments. Every piece is optimized to account for how students work, learn, think and fidget across every age and stage. From the beginning, we work alongside you to create the best spaces imaginable for teaching and learning — school by school, classroom by classroom.

Experience
our learning
environments
in our virtual
classroom.

smithsystem.com/virtual-school



walk through



Designed to Deliver



Design + Innovation

We're at our best when we're collaborating with schools, design firms, architects and furniture dealers across the country. Doing that work every day — talking curriculum and taking notes on how students learn — is the only way we know. We have a history of working with external product design teams who are experts in their fields to bring our concepts and insights to life.

Performance

We often describe the way we work as 'on-time' because there's no other way to describe how we work. Frankly, we believe there is no other way to work. Our business is highly seasonal, and when classes start up, we make sure our furniture is ready to go. It's taken a lot of learning and diligence to get to where we are today. Our customers keep returning, happily, to remind us that 'on-time' is the only way to be.

Quality + Value

The demand on schools to provide creative and inspiring learning environments for today's students is high. We help schools and districts meet that demand with furniture that is built for making, exploring, studying and collaborating. We make furniture that is built for learning. This simple credo drives the way we design, manufacture, assemble and deliver our products, so that our customers can get high-quality furniture at a price every district can afford.

Designed for every age, and every stage.

Early adaption.

From the first day of pre-K, furniture must adapt to the needs of shifty little learners. We design early education environments that stand up to these demands to help children thrive.

Formative years.

Design doesn't happen in a vacuum. Every consideration is made to provide elementary students the support and flexibility they need for success.

Growth spurts.

Kids grow quickly but at different paces. Our furniture is designed to grow with the student, while accounting for variations in size and shape and meeting everyone's own unique needs.

Social status.

Middle school presents its own challenges, but durability and comfort should never be sacrificed. We create unique spaces that serve as the foundation for collaboration.

Head of the class.

By high school, it's imperative to break down the barriers to engagement. Our furniture is proven to empower the next generation of learners and leaders.



Before you begin:

Explore our space, first.

SmithSystem.com is your launch pad. We've carefully assembled an online library of information to help you hone your knowledge and stimulate your imagination. It's the natural result when we have really passionate people with over a century of experience to share.

Find insights and inspiration.

Guides: modern classrooms, commons and makerspaces

BIM Files: Revit, 2D/3D DWGs; we're also up on 20/20 and Project Matrix

Videos: graduate movement, STEM environments and Cascade storage

Blog: current education trends, best practices and customer case studies

Continuing Education: AIA course and presentation outlines

Social Media: photo updates and news on Pinterest, Instagram and Twitter



What we offer educators.



Innovative Design

Beautiful furniture designed to create comfortable, healthy and engaging learning environments.



Exceptional Customer Care

An attentive sales force, 24/7 support, and the best customer service in the industry.



Durable

Seating, desks, tables and storage units that stand up to decades of wear and tear from students (and their backpacks).



On-Time Shipping

Orders made fresh to your specs and shipped without delay — even during peak season.



Customization

An impressive palette of color options for laminate tops, edges, paint and chair shells. Boost school spirit, stay subdued, or go bold.



Modern Thinking

Product lines that connect students to modern curricula and current research on how kids learn best.



Value

A wise investment in quality furniture that has become the brand of choice for many of the largest school districts in the states and abroad.



Environmental Health

Our entire product portfolio is 100 percent certified to meet indoor air quality standards for children and schools through UL GREENGUARD.



Great Warranty

A limited 12-year warranty, with a lifetime frame warranty. Find out more at smithsystem.com/about-us/warranty.

That's what our customers love most.

New for 2023

What's your new favorite?

Education is always evolving and so are we. We're excited to share the next generation of Smith System products that will transform your classrooms and learning spaces.



New for 2023

Numbers™ Cantilever Chair

Numbers Cantilever Chair is a winning answer for creating inspirational classrooms around the world. The chair delivers impressive benefits that add up for students and schools – great value, quality and comfort in a compact, sleek design that appeals to a range of ages. To optimize learning, the chair shell features 360-degree seating which allows kids to find their favorite sit. This chair also allows for flex through the robust frame design.

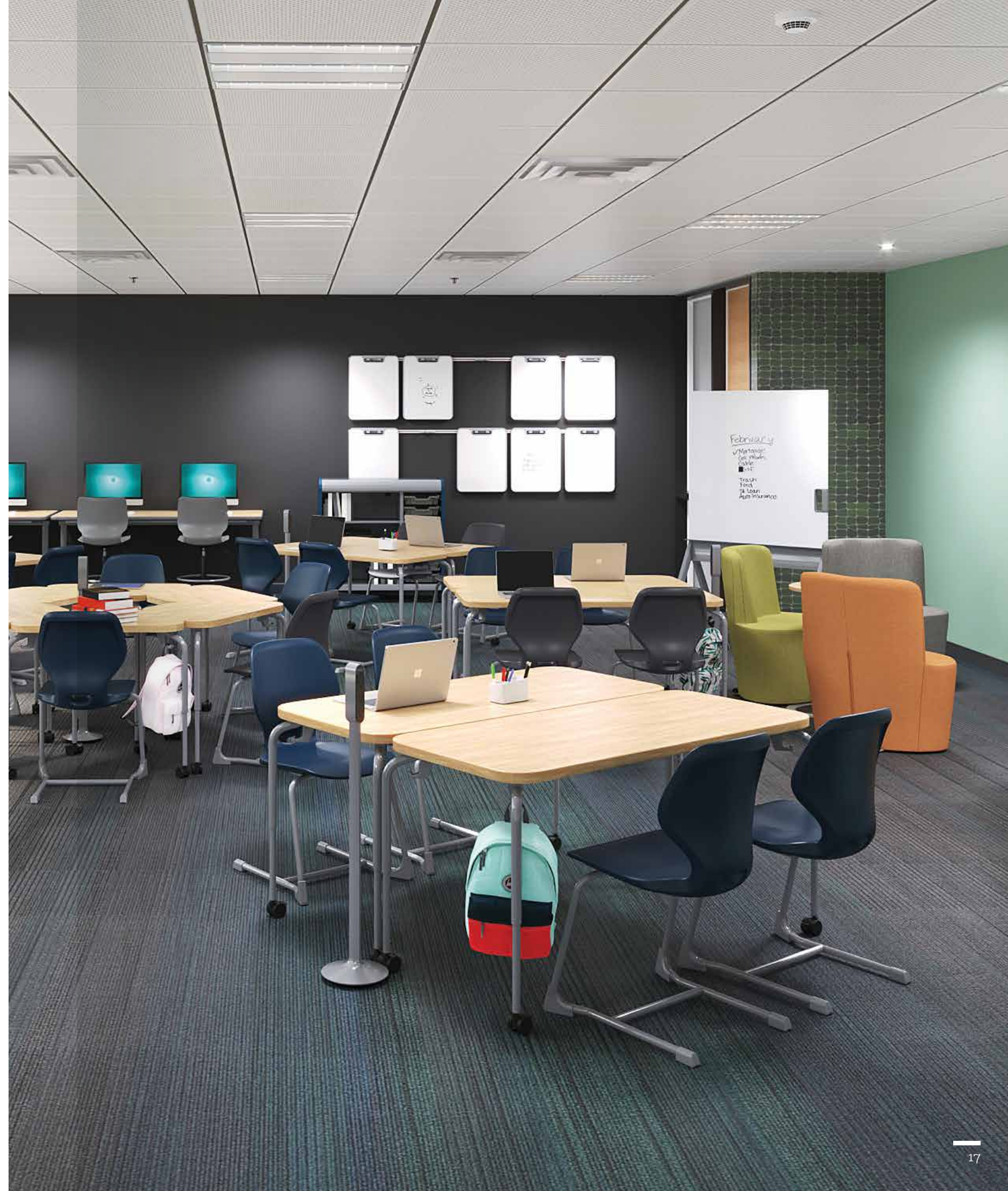

New for 2023

Numbers™ High Range Desk & Stool

Numbers Desk and Stool were created to address a conceptual need that emerged from early design charrettes: a value driven affordable K-12 desk and stool meeting specifications all over the world, providing unparalleled performance and visual subtlety. High Range desks paired with stools allow classrooms to be tiered providing dynamic seating that helps limit distractions.



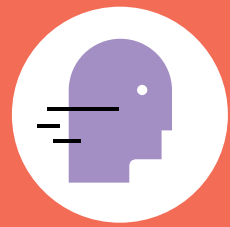

Learning Spaces:

Trends we see in education.

Our singular focus on furniture allows us to stay on top of emerging trends for new and unique spaces. As curriculum and technology evolve, we quickly adapt with furniture that fills real needs and meets the demands of modern learning. From esports studios to outdoor environments, one thing remains true: creativity and flexibility are at the forefront of design.

Esports

Video games have grown up out of the basement. Today, the esports industry is pacing a new generation of inspired students and is creating more opportunities to students at all levels.

VR Labs

Virtual reality remains at the cutting edge of learning and educational opportunities. A dedicated VR space can quickly transport students to far away worlds and unique learning experiences.

Informal Spaces

Hallways are no longer just for walking. Those overlooked school spaces could provide the perfect setting for personal study, small group collaboration or even larger group meetings.

Makerspaces

Some call it this. Some call it STEM or STEAM. Either way, it's an incubator for problem solving, creativity and collaboration. It must remain a highly versatile hotbed of engaging zoned spaces, materials and tools.

Tech Spaces

In today's computer labs, students need spaces to work both individually and collaboratively. The furniture selected needs to adapt to both situations.

Learning Commons

A successful learning commons is a subtly energizing environment where students can engage in a diverse array of learning activities. It's a place where kids migrate to between class and after school – it's a place where kids want to be.

Art Classrooms

The design and science of art furniture. When it comes to art classroom furniture, a couple of key characteristics are common to both. As expected, strength and durability come first. But today, the need to connect computers to power and wifi is gaining importance in art studios.



Esports: Merging Passion with Learning

The meteoric rise in high school esports shows it's much more than child's play. Esports has blossomed into a hot topic of conversation for its legitimate learning, spanning from K-12 to higher ed.

Gladly We Game





VR Labs: Creating New Realities for Real-World Applications

Imagine a student so viscerally immersed in learning that it's dizzying. That's the power of using virtual reality in the classroom, and it's capturing the attention of K–12 educators.

In the past few years, more schools have begun using immersive technology to bring classroom curricula to life. From one classroom, any student can be transported to the Pyramids of Giza or to holding a virtual human heart. There's great potential for these simulated experiences to transform the delivery of educational content, improve learning outcomes and democratize learning itself.





Informal Spaces: Breathing Life Into Overlooked Areas

A generation ago, school hallways were loud, cavernous corridors for corralling students. Today, those hallways have become valuable informal learning spots, reinforcing that learning can happen everywhere — even in the most unlikely places.

They have a lot of monikers, like in-between or pass-through areas, informal work zones, open learning spaces (outside too), lounges, niches, nooks and nests — you name it. But the purpose of informal learning spaces is similar. They are non-discipline-specific spots for self-directed student learning, working and socializing.

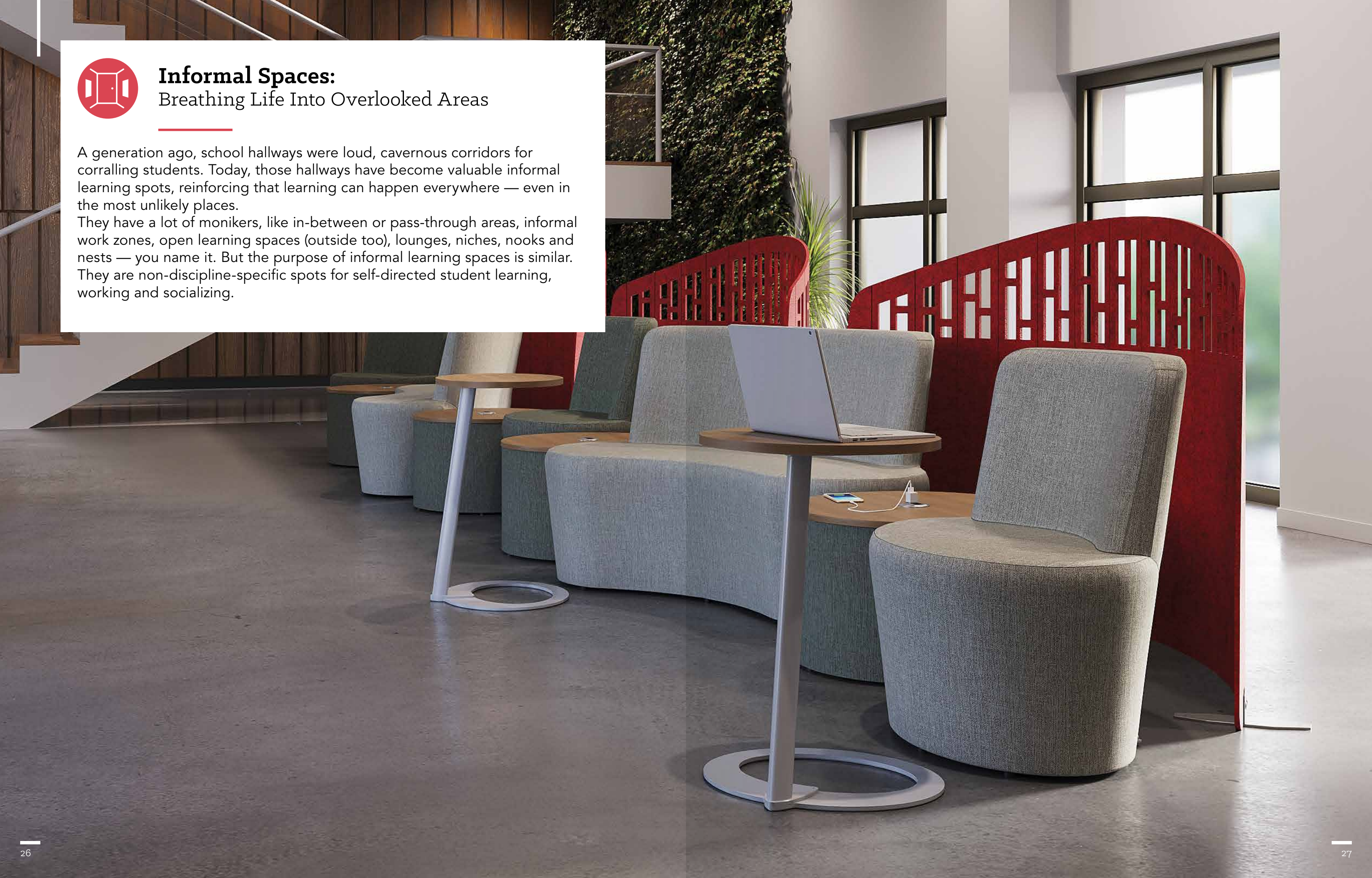



Makerspaces: Cool Labs for Hands-On Creating

Every student has maker potential. An educator's role is to manifest the maker mindset. That requires creating irresistible school makerspaces — incubators that get students excited to collaborate, think, tinker, design and build tangible products that solve real-world problems. Failure is expected, and welcomed. However, it takes creative thinking to make these DIY spaces. The best ones are a buzzy blend of science lab, woodshop, computer lab and art room that support project-based learning pedagogy.

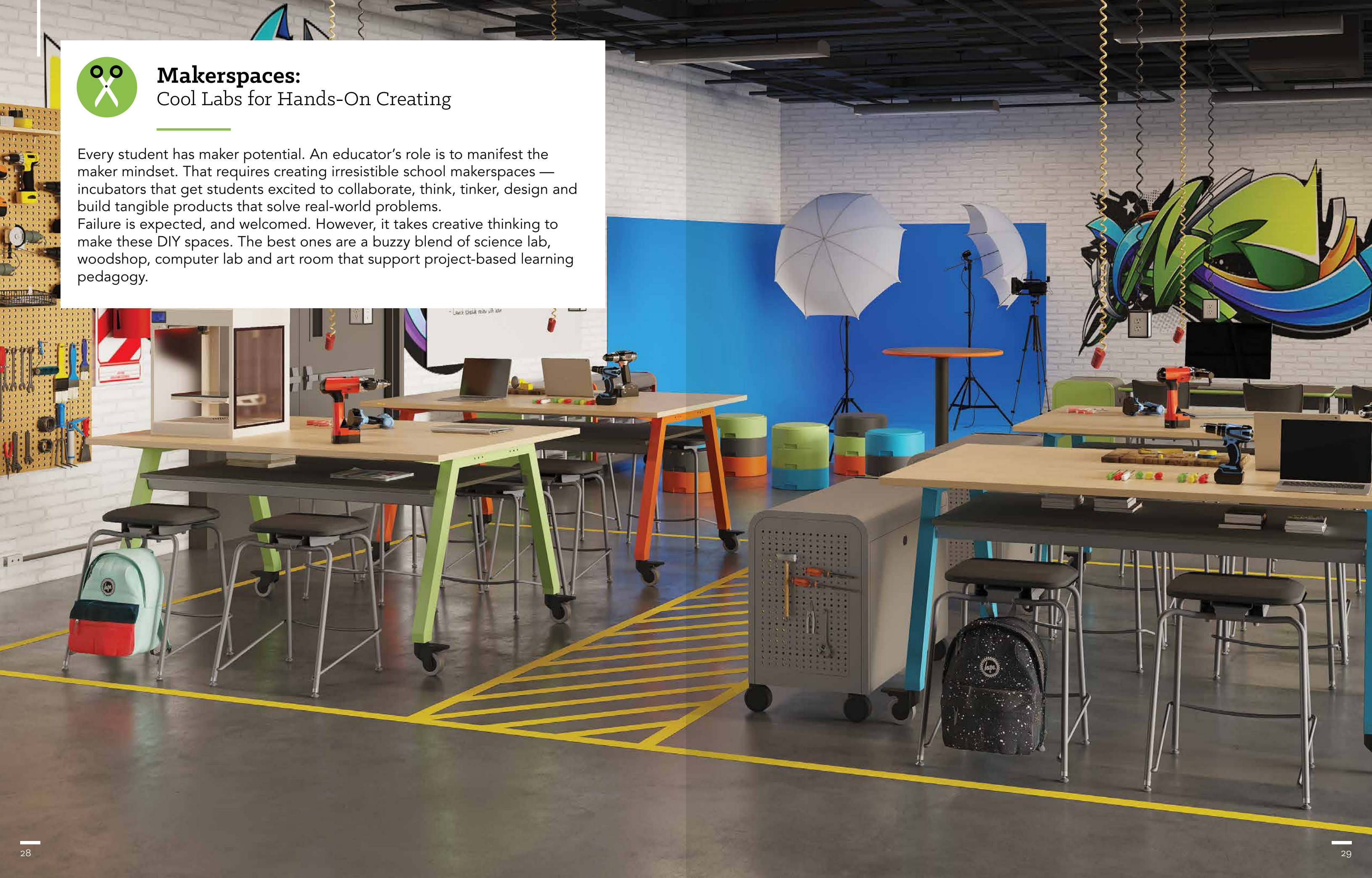



Tech Spaces:

Delineate Collaborative and Individual Learning Zones

Students are more tech-savvy than ever. Technology is practically in their DNA. Likewise, tech labs and computer labs must be ready to accommodate everything from beginning coding to high-level robotic competitions. We make the lab furniture to handle that spectrum.

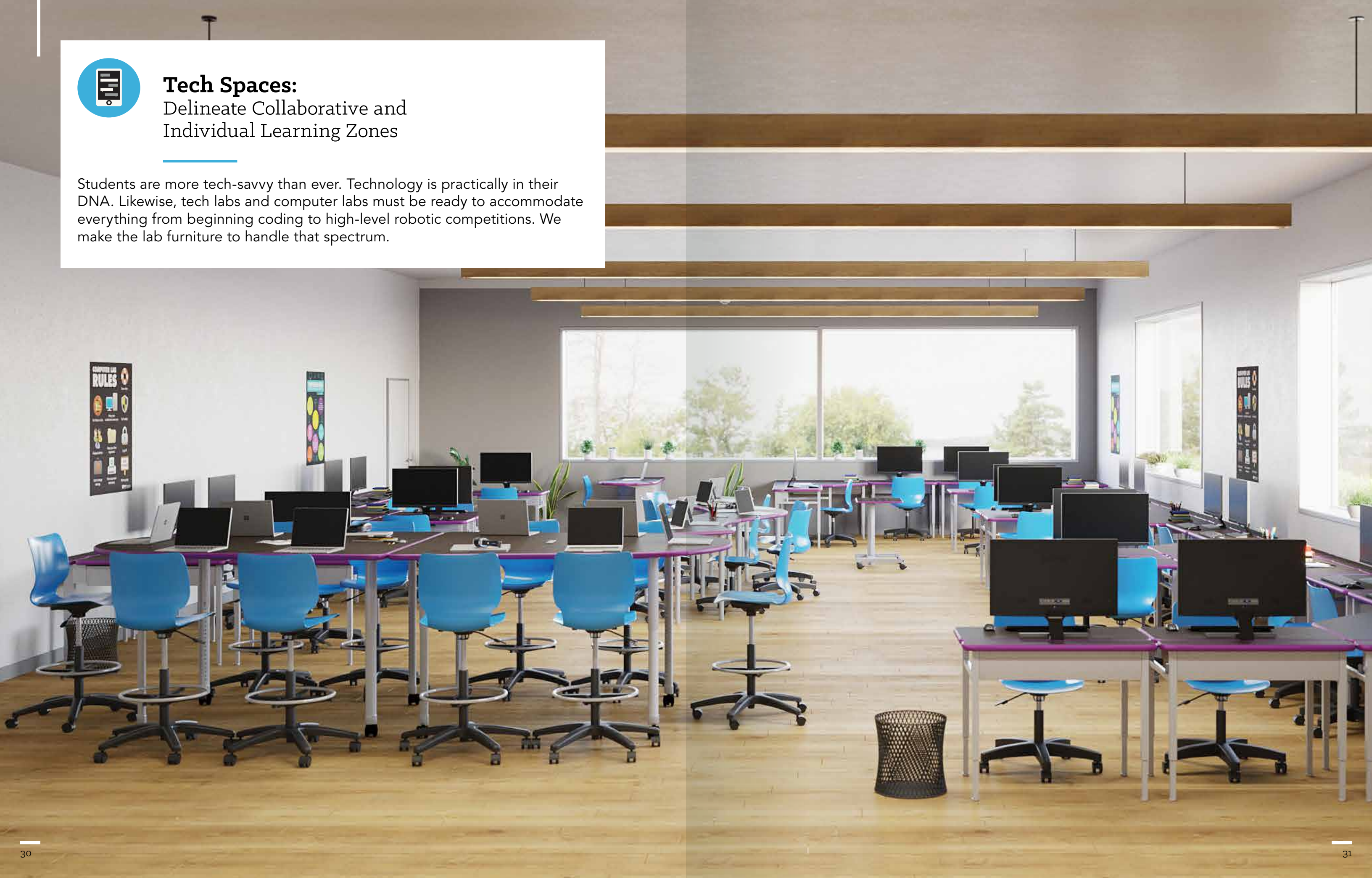



Learning Commons: Transforming Open Space

Successful learning commons are a subtly energizing environment where students can engage in a diverse array of learning activities. It's a place where kids migrate to between class and after school – it's a place where kids want to be. Individual study and research, group research and exchanges of ideas and information – all of these diverse actions can take place simultaneously in the learning commons.

** This product shown here only available for import from NA*

** This product shown here only available for import from NA*



Art Classrooms: The Design and Science of Art Furniture

When it comes to art classroom furniture, a couple of key characteristics are common to both. As expected, strength and durability come first. But today, the need to connect computers to power and wifi is gaining importance in art studios. Not surprisingly, learning environments for these spaces are enhanced with exposure to the outdoors.



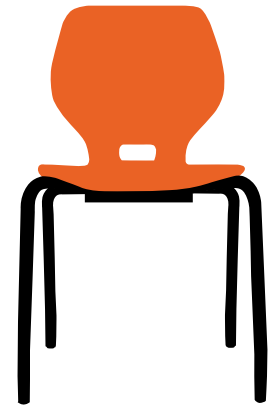

Seating

Seating is as unique as a fingerprint. Students sit in thousands of different positions — upright, slouched, twisted and tilted. They stretch out their legs, sit on them, cross them and bounce them. They will balance on their chair or teeter on the back, tempting gravity — and common sense.

Built for Learning.



* This product shown here is only available for import from NA.

* This product shown here is only available for import from NA.

Seating

Learning has evolved. Seating has adapted.

Like all of our furniture, our seating concepts were developed for PreK-12 students. From their very specific size ranges to their innovative contours — these seating options are ready for learning in any environment or situation.



Flavors®

Offers increased movement and four seating positions. Its seatback flexes front to back and torsionally, allowing students to shift and move without chair resistance.



Numbers™

An exceptional K-12 furniture solution that meets global requirements. Numbers offers a value driven, affordable chair, providing unparalleled performance and visual subtlety.



Oodle®

A revolutionary active seating line that puts the fun in classroom functionality. Featuring a unique movement disc base that allows for 10 degrees of movement.



Flowform®

Our Flowform line features deliberate organic shapes with soft radii and rounded edging. They work individually or loosely slide together, giving students endless options to make micro-adjustments.

Which ergonomics matter most?

Here are some ways administrators can get the most ergonomic bang for their buck.

Right Fit/Adjustable.

- Both seating and desks need to be properly scaled to fit the size of the individual student.
- We offer a wide range of heights in seating — typically four or five per product line. Our desking lines are adjustable in height as well.

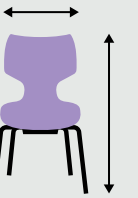

Right Size.

- Properly sized classroom seating supports healthy posture and decreases fidgeting.
- Students should be able to sit with their feet firmly planted on the floor and their backs against their chairs.

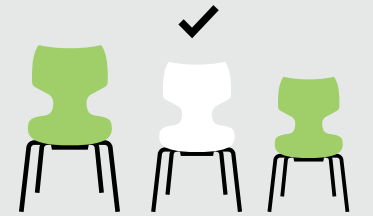

Function.

- 21st century learning often requires seating to be moved throughout the day, so chairs must be light enough, or fitted with casters, to allow students of all ages to move them quickly and easily.

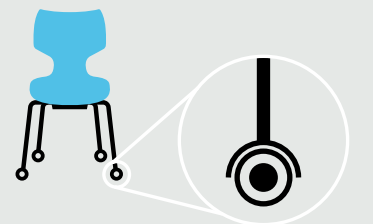

Seating that Doesn't Fight the Student.

- A chair that allows some movement on the part of the student can promote learning. But how much movement?
- Consider our Graduated Movement Concept, an idea educators can use to tailor the ergonomics of the classroom furniture to support the curriculum. Though subtle differences in design, our Groove, Flavors and Numbers lines allow moderate movement while Oodle, Flavors & Groove Noodle, and Theorem permit the utmost movement.



Size Guide

Calculated for success.



Calculated for universal appeal.

Numbers chair provides a value-driven, high-quality solution for K-12 classrooms around the world. That freed us to design the chair's front entirely separate from its back, with variable thickness and a fully integrated frame. And, it's our first product line to meet international BIFMA EN and GB requirements for size, safety conformance and durability.

1-2-3 global markets.

We designed Numbers with a winning formula that meets classroom furniture standards of three major world markets—EMEA (Europe, the Middle East and Africa), Asia-Pacific and the Americas.

Comfortable blow-molded shell

Blow-molding let us add shell volume, then nestle the frame in the seatpan. A molded undershell provides added strength, especially for sitters who favor leaning back. The integrated aesthetic is easier to clean, too. With no vent holes on the top of the seat pan, you don't have to worry about any soiling or mold formation inside the chair shell.

Shell Color Options:



Frame Color Options:



Glide Options:
Nylon base glides are standard.

Felt glide option:
Add 'F' to follow Model No.

Model	Description	D"	W"	H"
22845	Numbers 10" Stack Chair (Size 1)	16.5	15	10
22846	Numbers 12" Stack Chair (Size 2)	16.5	15	12
22847	Numbers 14" Stack Chair (Size 3)	16.5	15	14
22839	Numbers 15" Stack Chair (Size 4)	18.5	17	15
22848	Numbers 16" Stack Chair (Size 5)	18.5	17	16
22849	Numbers 18" Stack Chair (Size 6)	21.5	19	18
22860	Numbers 14" Mobile Chair (Size 3)	17	16	14
22850	Numbers 15" Mobile Chair (Size 4)	19.5	18	15
22854	Numbers 16" Mobile Chair (Size 5)	19.5	18	16
22855	Numbers 18" Mobile Chair (Size 6)	21.5	20	18

Numbers Stack Chair



Model 22849

Numbers Mobile Chair



Model 22855

Numbers Desk line featured on page 72.



Homework

- * Page 6-8 of Workbook
- * Read Chapter 12-14
- * Lab report

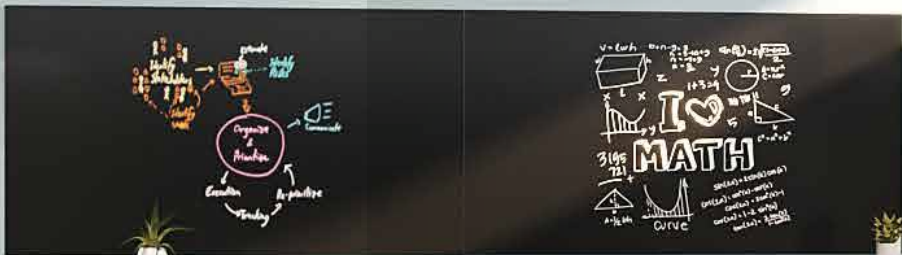

Planner®
Mobile
Whiteboard

Cascade®
Teachers
Desk

Numbers
Trapezoid
Table

Numbers
Petal
Desk

Numbers
Stack
Chair

A four-position chair
perfect for project
learning situations.



Stack Chair



Mobile Stack Chair

Freedom of movement.

Flavors seating eliminates as many restrictions to student movement as possible.

- A relatively flat seatpan with a waterfall front allows the student to comfortably face front, back and either side.

Less restricting to the shoulders and spine.

To further enable the student to work with students on either side, the seatback provides torsional flex — allowing the student to gently twist to face left or right.

Move, breathe and concentrate.

A subtle front-to-back flex allows the student to move and adjust their posture, which promotes better concentration.

For classrooms that move and students of all sizes.

- Flavors seating is light enough for most students to move in the classroom without a problem.
- Achieve additional mobility with casters on the Adjustable Chair, Stools and Mobile Stacking Chair.
- Stacking models come in six sizes, so you can pair the appropriately sized chair with the student.

Construction. Built for the demands of a school environment.

- The durable, high-density polypropylene shell stands up to the challenges of a real-world classroom.
- Made of 18-gauge welded steel, the frame is protected with chrome plating or a rugged powder coat finish.
- For added comfort, the shell rests directly on the frame (not on the rivets).



Model 11847 14"(356mm) seat height, 'B' Shell. Shown in Apple.	Model 11848 16"(406mm) seat height, 'B' Shell. Shown in Blueberry.	Model 11849 18"(457mm) seat height, 'A' Shell. Shown in Black.	Model 11844 8"(203mm) seat height, 'C' Shell. Shown in Cerulean.	Model 11845 10"(254mm) seat height, 'C' Shell. Shown in Purple.	Model 11846 12"(305mm) seat height, 'C' Shell. Shown in Navy.
--	--	--	--	---	---

Note :
* The smaller three sizes are not localized in APAC, available to order from US.



Flavors Stack Chair

Four-position chair allows student to sit comfortably facing front, either side or rear. Flexing seatback provides support and allows student to turn with less restriction. Flat seatpan with waterfall front edge. Three sizes. Available in 4 colors.

- The shell rests on the frame, not rivets to add comfort.
- High-density polypropylene with color throughout the shell.
- Durable swivel-base glides, with non-staining nylon bases and chrome-plated steel covers come standard.
- Choose optional steel or felt glides.
- The legs are strong, 18-gauge welded steel with a durable chrome finish.
- Chrome legs with durable chrome finish or Platinum powder coat finish.
- Stacks four chairs high.



Flavors Mobile Stack Chair

Four-position chair allows student to sit comfortably facing front, either side or rear. Flexing seatback provides support and allows student to turn with less restriction. Flat seatpan with waterfall front edge. Available in 4 colors.

- The shell rests on the frame, not rivets, to add comfort.
- High-density polypropylene with color throughout the shell.
- The legs are strong, 18-gauge welded steel.
- Chrome legs with durable chrome finish or Platinum powder coat finish.
- Mobile chairs recommended for use on carpeted flooring.



Model 11846
12"(305mm) seat height,
Shown in Apple.



Model 11847
14"(356mm) seat height,
Shown in Charcoal.



Model 11848
16"(406mm) seat height,
Shown in Cerulean.



Model 11849
18"(457mm) seat height,
Shown in Orange.



Model 11854
16"(406mm) seat height,
Shown in Cerulean.



Model 11855
18"(457mm) seat height,
Shown in Charcoal.



Model 11889
24"(610mm) seat height,
Stool A Shell
Shown in Orange.



Model 11891
30"(762mm) seat height,
Stool A Shell
Shown in Cerulean.

A new revelation for classroom functionality.



See more:
meet-oodle.com



Stack



Mix



Move



Meet Oodle.

Often our pursuit of designs that inspire the minds of students takes us to places we never would have imagined even five or 10 years ago. One such result is here. Meet Oodle, the all-new active seating line that is as fun to explore as it is to say.

Switch it up.

Keep your space fresh by switching things up in a flash. You're never stuck with one height or one color. And the unique rocker base system maximizes versatility. Sit flat, or sit with movement, on the very same stool.



Moving up.

The colorful 6 1/2-inch (165mm) sections stack and twist to engage a unique stool-to-stool locking system. Educators can easily assist students to make the stool taller or shorter.

Holding up.

Oodle's 17-inch (432mm) diameter is perfect for all ages and sizes of student. Sturdy polypropylene material holds up to all elements.

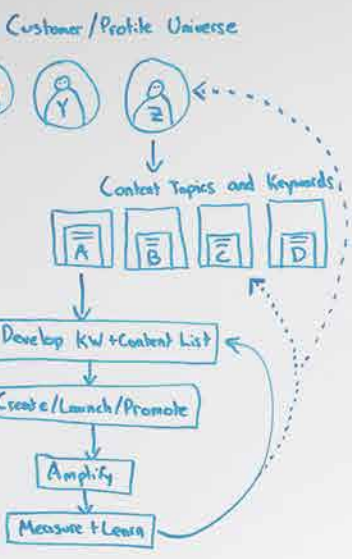

Oodles of possibilities.

The unique base design incorporates a structural disc that when flipped 180 degrees provides the student with the ability to wiggle. Or, if the student or teacher chooses, sit flat. Model Oodle31 comes with three sections and one rocker base. Model Oodle33 comes with three sections and three rocker bases.



Oodle® Seating



Oodle Stools and Elemental 6-star table is available to order from US. Oodle stools shown in Apple, Charcoal and Platinum.



Oodle seating paired with Elemental Tables and Flavors Seating.

Mix, match and stack.

To stack, rearrange your colors or use Oodle in different configurations. Restacking is a breeze, just find the circular indicator and snap Oodle into place.

Pair Oodles with matching tables from our Elemental® and Planner® Studio lines or match edge band colors from our Interchange® table line.

Choice of height.

Because Oodle comes in three 6 1/2-inch (165mm) sections sections, teachers don't have to be stuck with a single height stool in their classrooms and commons areas. And students are free to choose the height they feel most comfortable with for the activity at that moment. For example, four 19 1/2-inch (495mm) Oodles can be used as six 13 1/2-inch (343mm) Oodles in the morning, and twelve 7 1/2-inch (191mm) Oodles in the afternoon.

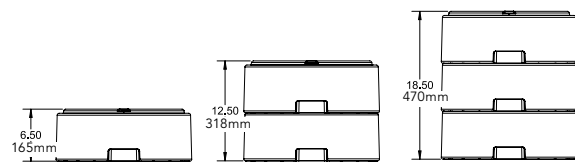

Height with Rocker Base Disengaged

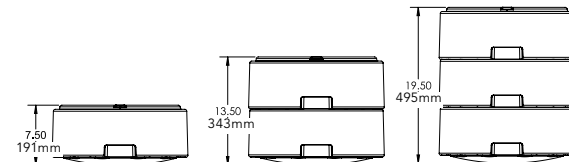

Height with Rocker Base Engaged

All students welcome.

Students come in all shapes and sizes. In the design of Oodle, we considered every body type. With 17 inches (432mm) of seating surface, larger students will feel just as welcome using an Oodle.



17"(432mm)

Seat diameter measures 17"(432mm) Ensuring every student feels comfortable, weight limit 250lbs.

Comfortable motion.

Featuring a modest 10 degrees of motion, Oodle's edge is designed to catch a student before he or she is able to lose their balance. And, of course, motion is optional on Oodle.



Oodle moves only so far before the built in 'stop' engages at 10° of rocking. This prevents the user from feeling unstable.

Something soft from Smith System.



Design forward.

Soft to the touch, Flowform seating adds a new level of comfort and flexibility to more spaces. Built for collaborative groups of all sizes or solo study, the Flowform line adds a softer feel without sacrificing durability or maneuverability.

Soften your space.

Flowform seating has a soft touch and ample cushion for lasting comfort in multiple positions. Underneath it all sits a reinforced frame for long-lasting strength.

Create and collaborate.

Easily rearrange Flowform seating in limitless configurations for collaboration of all shapes and sizes.

Built to last.

The highly durable, highly washable vinyl fabric suits classrooms of all ages and easily wipes down at the end of the day.

Model	Description	D"	W"	H"	WT.
SMSFS55000	Flowform Soft Rocker	26.25	20.5	25.5	18
SMSFS55001	Flowform Ottoman Circle	26 dia.		15	19
SMSFS55002	Bean Bench - Small	20.5	41	18	40
SMSFS55003	Bean Bench - Large	24.5	58	18	60
SMSFS55004	Straight Bench	19	59	18	60
SMSFS55005	Bench Divider - Curved	19	59	26	71
SMSFS55006	Bench Divider - Straight	13	44.5	26	58
SMSFS55008	Flowform Square Ottoman	19	19	18	21
SMSFS55009	Flowform Hexagon Ottoman	20.5	23	18	19
SMSFS55010	Flowform Stool Tapered Cylinder	19 dia.		18	17

Standard Vinyl Color Options:



Flowform® Seating

Flowform Bean Bench – Small



Model SMSFS55002

Flowform Bean Bench – Large



Model SMSFS55003

Flowform Curved Bench Divider



Model SMSFS55005

Flowform Straight Bench



Model SMSFS55004

Flowform Straight Bench Divider



Model SMSFS55006

Flowform Soft Rocker



Model SMSFS55000

Flowform Ottoman Circle



Model SMSFS55001

Flowform Stool Tapered Cylinder



Model SMSFS55010

Flowform Square & Hexagon Ottoman



Model SMSFS55008 & SMSFS55009



*Theorem®
Rod Frame
Stool*

*Planner®
Studio
Adjustable
Height
Table*

*Flowform
Round
Rectangle
Table*



Flowform® Seating



Model SMSFS55000
Shown in Pistachio and Apricot fabric.

Flowform Soft Rocker

The Soft Rocker offers a new style of movement-based active seating. The rocking action promotes engaging interaction with others. Children, adolescents and even adults love the rocking motion of the Soft Rocker.

The Soft Rocker is constructed of durable, kiln-dried, solid hardwood with a poplar plywood frame, which is corner blocked at load-bearing connections. The back frame is webbed for structural integrity. The seating pad is made from high-density foam meeting FR CA117 standards and contains no added flame retardant chemicals.

- Designtex 100% vinyl fabric, phthalate free.
- 100,000 Wyzenbeek double rub (CD) rating.
- Polyester fabric backing.
- Easily cleanable with a 10:1 water:bleach mixture.

Soft Rocker Color Choice

- Pistachio PIO
- Mediterranean MDT
- Iron ION
- Apricot APR
- Fog FGO



See more:
smithsystem.com/softrocker

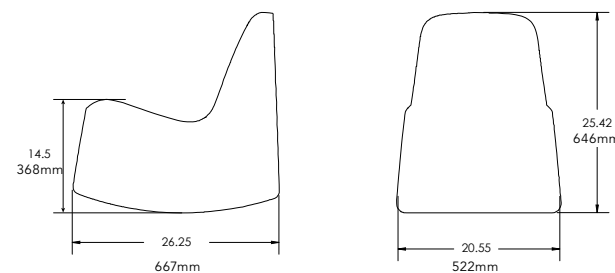

Create a fresh space for flexible – and rockable – learning.



Flowform Ottoman

The 26" ottoman pairs well with our Soft Rocker or on its own to create comfortable work spaces for young adult learners. Collaborate with others and interact in a close-knit space. The ottoman is constructed of durable kiln-dried pine solid hardwood with a poplar plywood frame, which is corner blocked at load-bearing connections. The back frame is webbed for structural integrity. The seating pad is made from high-density foam meeting FR CA117 standards and contains no added flame retardant chemicals.

- Designtex 100% vinyl fabric, phthalate free.
- 100,000 Wyzenbeek double rub (CD) rating.
- Polyester fabric backing.
- Easily cleanable with a 10:1 water:bleach mixture.

Ottoman Color Choice

- Pistachio PIO
- Mediterranean MDT
- Iron ION
- Apricot APR
- Fog FGO

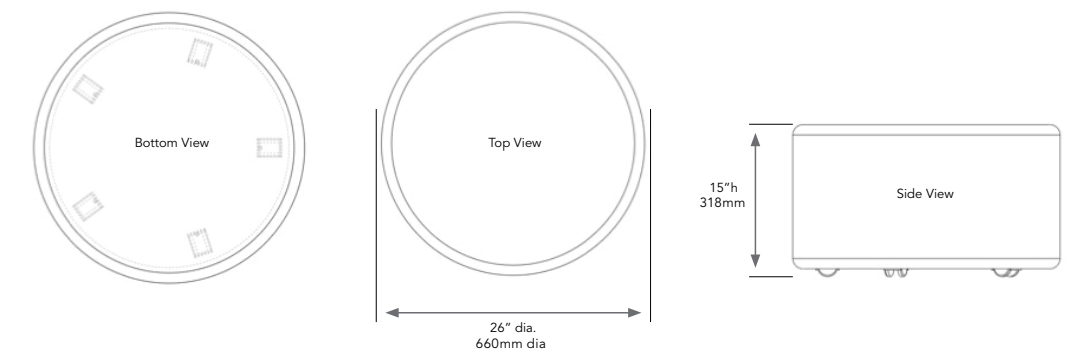

Flowform® Seating



Flowform Tapered Cylinder Stool

Flowform Soft Seating from Smith System helps create unique collaborative interaction spaces for kids of all ages. Flowform soft seating is available in 4 shapes, with 2 divider wall sizes to create barriers — when space is needed. The frame is constructed of durable 18mm birch plywood veneers, each piece interlocking with adjacent pieces to create sturdy load-bearing connections. Thermoplastic polyester fiber upholstery batting minimizes telegraphing of the framework through the vinyl exterior. The seating pad is made from flexible polyurethane foam, meeting FR CA117 standards, and contains no added flame-retardant chemicals.

- Designtex 100% vinyl fabric, phthalate free.
- Polyester fabric backing.
- 1,000,000 Wyzenbeek double rub (CD) rating.
- Easily cleanable with a 10:1 water:bleach mixture.

Stool Color Choice

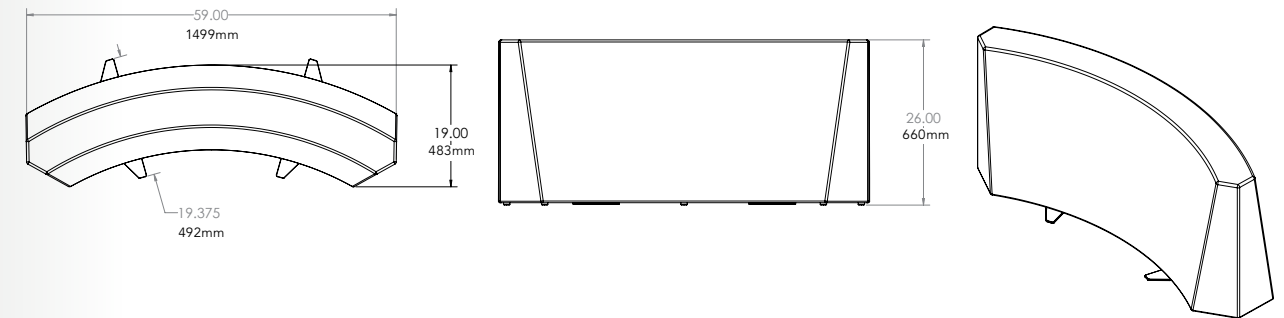
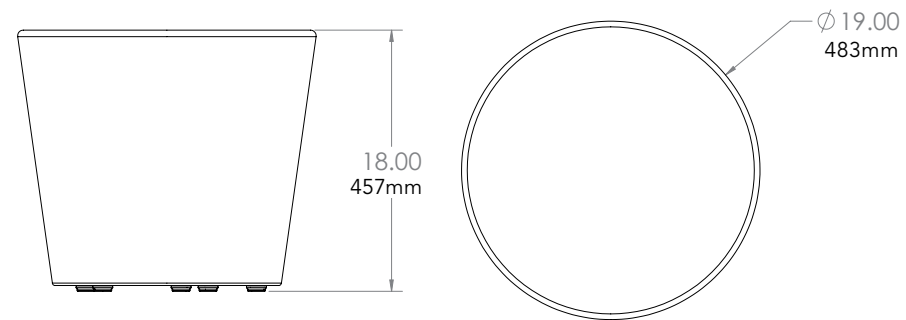

Flowform Bean Benches & Wall

Flowform Soft Seating from Smith System helps create unique collaborative interaction spaces for kids of all ages. Flowform soft seating is available in 4 shapes, with 2 divider wall sizes to create barriers — when space is needed. The frame is constructed of durable 18mm birch plywood veneers, each piece interlocking with adjacent pieces to create sturdy load-bearing connections. Thermoplastic polyester fiber upholstery batting minimizes telegraphing of the framework through the vinyl exterior. The seating pad is made from flexible polyurethane foam, meeting FR CA117 standards, and contains no added flame-retardant chemicals.

- Designtex 100% vinyl fabric, phthalate free.
- Polyester fabric backing.
- 1,000,000 Wyzenbeek double rub (CD) rating.
- Easily cleanable with a 10:1 water:bleach mixture.

Color Choice

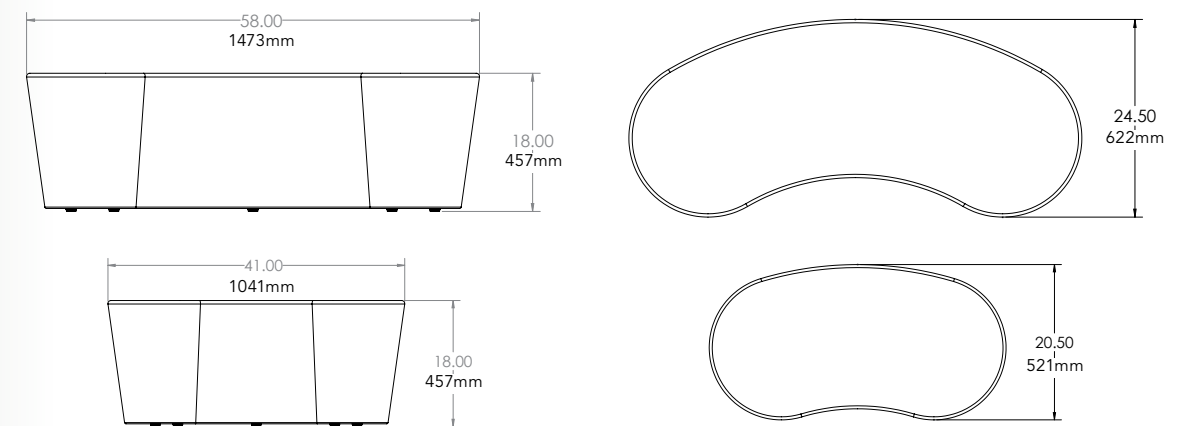

All the tools to build bold, new learning spaces.

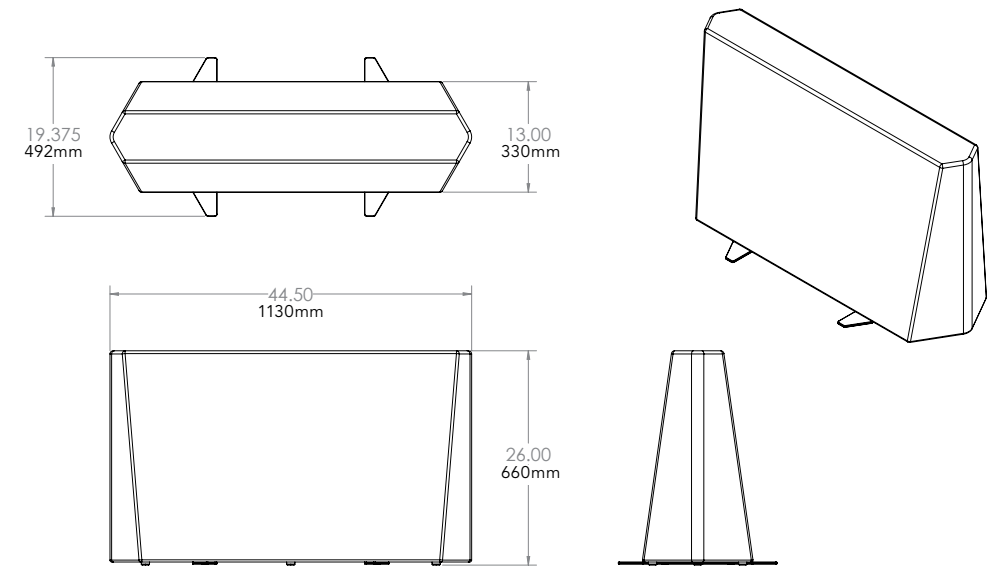

Flowform Straight Bench & Wall

Flowform Soft Seating from Smith System helps create unique collaborative interaction spaces for kids of all ages. Flowform soft seating is available in 4 shapes, with 2 divider wall sizes to create barriers — when space is needed. The frame is constructed of durable 18mm birch plywood veneers, each piece interlocking with adjacent pieces to create sturdy load-bearing connections. Thermoplastic polyester fiber upholstery batting minimizes telegraphing of the framework through the vinyl exterior. The seating pad is made from flexible polyurethane foam, meeting FR CA117 standards, and contains no added flame-retardant chemicals.

- Designtex 100% vinyl fabric, phthalate free.
- 1,000,000 Wyzenbeek double rub (CD) rating.
- Polyester fabric backing.
- Easily cleanable with a 10:1 water:bleach mixture.

Color Choice

- Pistachio PIO
- Mediterranean MDT
- Iron ION
- Apricot APR
- Fog FGO

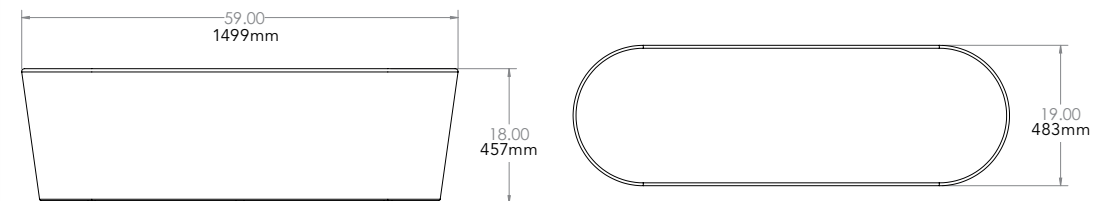

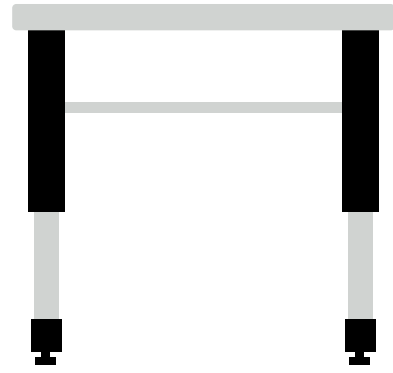

Desks & Tables

Today's learning environments present an unprecedented challenge to desks and tables, demanding greater versatility and durability. Our desks and tables are designed for multiple reconfigurations — pods, pairs, rows and more — and are reinforced to withstand the constant movement.

Built for Learning.



Desks & Tables



Numbers™

To conserve space, the desks have a compact design. Their leg form, coupled with felt-bottom backpack hooks on all four legs, allow easy slide-on stacking — three or four desks at a time. The laminate top is 1.25 inches thick in North America; 25 mm for Europe and Asia.



Flowform®

This sleek, contemporary table designed for collaborative learning provides sleek looks, solid functionality and great flexibility. It can be arranged in countless ways for groups of all sizes. Its work surface provides ample space for work of all kinds.



Interchange®

The highly versatile Interchange line of contemporary classroom desks and tables features legs that easily adjust from 22 to 34 inches in height. Choose from many shapes, all of unbeatable engineering and beauty.



Elemental®

It's not all just colors and shapes on the Elemental line. Leg and caster options provide even more versatility. Elemental Tables come with three leg choices: Fixed-height with glide (EG), Fixed-height for caster (EC), or Adjustable-height (EA). Each leg style is available in 5 contemporary colors.



Silhouette®

The Silhouette desk is a contemporary, economic solution for traditional and collaborative classrooms. Its durable cantilevered design, adjustable legs, and optional storage accessories make it a timeless favorite. Single and two-student options available.



Planner®

Every student deserves an unshakable foundation for learning. Planner desks and tables deliver via a heavy-duty, steel frame and leg system. This line is suited to a variety of subjects, including art, maker labs, STEM learning, and more.

Beyond design, consider how it's engineered and built.

Right Size

Fitting the chair and desk or table to the student is important, as a proper fit helps academic performance while a poor fit hinders it.

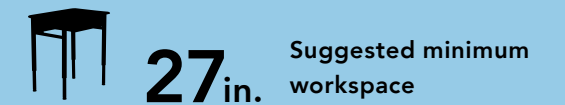

Healthy Construction

Smith System desks and tables are made for healthy learning environments, and are UL GREENGUARD Gold Certified with the exception of butcher block.

Suggested Desk and Chair Heights:

Table Height	~19"	~22"	~24"	~27"	~29"
Chair Seat Height	10"	12"	14"	16"	18"
3-4 year olds	50%	50%			
Kindergarten		50%	50%		
Grade 1			100%		
Grade 2			25%	75%	
Grade 3-4				100%	
Grade 5				50%	50%
Grade 6-12					100%

Dependability

Smith System backs its tables and desks with a lifetime warranty on the frame and legs and a 12-year warranty on table tops and desk tops.

Availability

Smith System employs lean manufacturing techniques, allowing us to make tables and desks to order and ship them.

A new benchmark in comfort, strength, design.

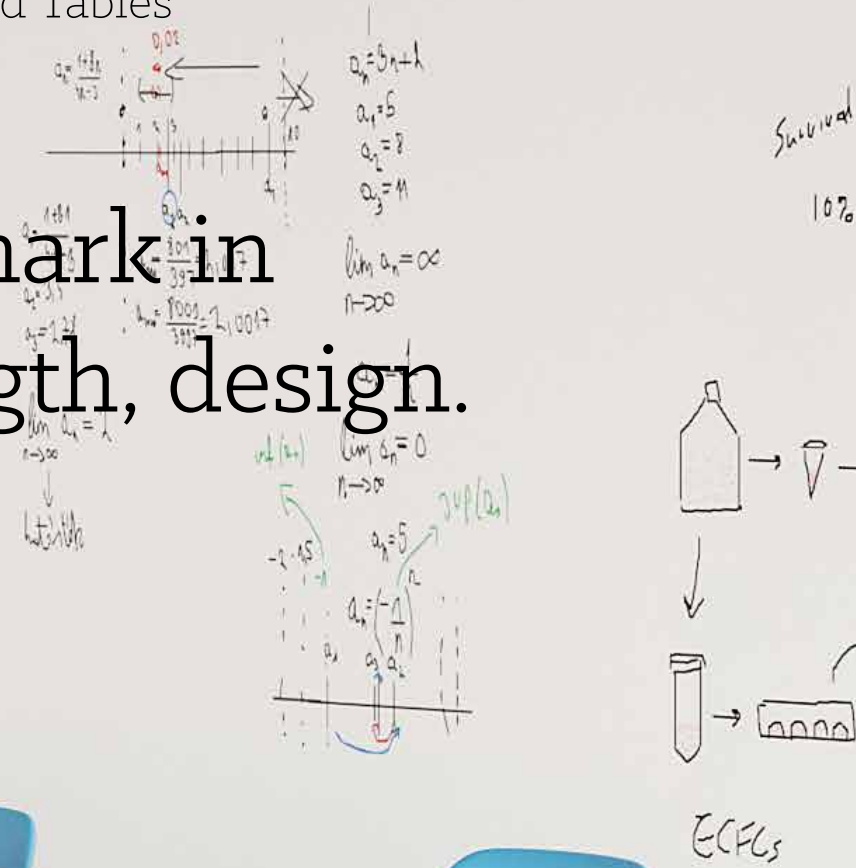

The perfect pairing.

To complete the Numbers equation, we designed its companion: the versatile Numbers Desk. Together, the chair and desk set equals a smart solution for students, teachers and facility personnel.

Adjustable height & casters.

These desks can quickly be adjusted in height and have discreet set screws which are inside the legs allowing for smooth legs. Standard inserts range from 24.5 to 30 inches; low-range inserts are 19 to 24.5 inches. The High Range Desk Table adjusts from 27" - 42" in 17.5 mm increments. In addition, the inner leg tube can flip between glides or casters (sold separately), which allows for wheelbarrowing without affecting desk height.

Slide-on stacking.

To conserve space, the desks have a compact design. Their leg form, coupled with felt-bottomed backpack hooks on all four legs, allows easy slide-on stacking — three or four desks at a time. The laminate top is 1.25 inches thick in North America; 25 mm for Europe and Asia.



Numbers Chair line featured on page 40.

Model	Description	D"	W"	H"	WT.
SMNBR02130L	Numbers Student Desk	20	27	24.5-30	37
SMNBR02131L	Numbers Huddle Student Desk	22	32	24.5-30	38
SMNBR02132L	Numbers Petal Student Desk	29.5	29.5	24.5-30	39
SMNBR02133L	Numbers Triangle Student Desk	29	32	24.5-30	31
SMNBR02140L	Numbers 24 x 48 Two-Student Desk	24	48	24.5-30	56
SMNBR02141L	Numbers 24 x 54 Two-Student Desk	24	54	24.5-30	63
SMNBR02142L	Numbers 30 x 60 Table	30	60	24.5-30	79
SMNBR02143L	Numbers 30 x 60 Trapezoid Table	30	60	24.5-30	68
Numbers High Range Desk					
02240	Numbers 24 x 48 Two-Student Desk	24	48	27-42	62
02241	Numbers 24 x 54 Two-Student Desk	24	54	27-42	69
02242	Numbers 30 x 60 Table	60	30	27-42	85
02243	Numbers 30 x 60 Trapezoid Table	60	30	27-42	74
Optional Accessories					
60161	Numbers Desk Low Range Insert (4 pk) Only compatible with standard height				3

*Bookboxes not compatible with 02141, 02142, 02241, and 02242 Numbers Desk models.

Low Pressure Laminate (with optional matching 2mm Edge Band):



Leg Color:



Note :

*** HPL and T-Mold edge band options to be available Q4/FY24.
*** HPL and T-Mold edge band options available end of 2023.



Optional PET Bookbox
17195
Bookboxes not compatible with 02141, 02142, 02241, and 02242 Numbers Desk models.

Numbers™ Student Desks and Tables

Numbers Student Desk 20x27



Model SMNBR02130L

Numbers Huddle Student Desk



Model SMNBR02131L

Numbers Petal Student Desk



Model SMNBR02132L

Numbers High Range Two-Student Desk 24x48



*Model 02240**

Numbers High Range Two-Student Desk 24x54



*Model 02241**

Numbers High Range Table 30x60



*Model 02242**

Numbers Triangle Student Desk



Model SMNBR02133L

Numbers Two-Student Desk 24x48



Model SMNBR02140L

Numbers High Range Trapezoid Table 30x60



*Model 02243**

Note :
* These style numbers will be available end of 2023.

Numbers Two-Student Desk 24x54



Model SMNBR02141L

Numbers Table 30x60



Model SMNBR02142L

Numbers Trapezoid Table 30x60



Model SMNBR02143L





Flowform®
Storage

Numbers®
Triangle
Desk

Numbers®
Mobile
Chair



Our new line of tables really go with the flow.



Oval Pedestal



Rounded Triangle



Clamshell



Rounded Rectangle



Rounded Trapezoid



Offset Rectangle



Offset Triangle

360 degree effectiveness.

Unique shapes and rounded edges invite more movement around the table for easier access and mobility among students at every level.

Professional grade.

A fresh approach to surface structure and leg design provides more durability and a quality you appreciate immediately.

Scale up or down.

In collaboration with Flowform seating, Flowform tables reconfigure in countless ways, from large-group collaboration down to individual study.



books learning



Flowform Tables

This compact, contemporary table designed for collaborative learning provides sleek looks, solid functionality and great flexibility. It can be arranged in countless ways for groups of all sizes. Its work surface provides ample space for work of all kinds. Features angled triangular shaped leg and organic shaped tops. The curvature works well with the Flowform Soft Seating and Mobile Storage. Order them in 9 laminates with matching 2mm edge banding, Silver frame only.

- Durable 3/4"(19mm) thick desktop, with a low-pressure laminate surface.
- Rugged powder-coat surface on legs resists wear.
- Option of casters or glides.

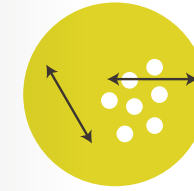

Contemporary looks, over and over again.



Flowform Clamshell, Model SMORB56003L
Shown in Seagull top and platinum frame.



Flowform Rounded Triangle, Model SMORB56002L
Shown in Maple top and platinum frame.



Flowform Rounded Rectangle, Model SMORB56006L
Shown in Maple top and platinum frame.



Flowform Oval Pedestal, Model SMORB56000L
Shown in Warm Elm top and platinum frame.

Flowform® Tables



Flowform Offset Rectangle, Model SMORB56010L
Shown in Acacia top and platinum frame.



Flowform Offset Rectangle, Model SMORB56011L
Shown in Seagull top and platinum frame.



Flowform Rounded Trapezoid, Model SMORB56008L
Shown in Maple top and platinum frame.

Interchange® Desks & Tables

Unique surfaces to
create an unlimited
number of possibilities.



Interchange® Desks & Tables



Wing Desks



Diamond Desks



Diamond Mini Desk



Student Desks



Squiggle Table



Cookie Table



3-2-1 Desk

Contemporary styling, solid functionality and innovative desktop designs.

For 21st century classrooms.

Its unique combination of functionality, style and practicality gives the Interchange line its innate unity and beauty.

- Interchange Wing, Diamond and 3-2-1® Desks for collaborative learning (and traditional) classrooms.
- Interchange Student Desks for traditional classrooms.

Dependability.

Lifetime warranty on the frame and legs, 12-year warranty on table and desktops.

Healthy construction.

SCS Indoor Air Advantage™ Certified.

Unbeatable construction.

- The T-Mold edge band, used on Interchange Desks and Tables, is stapled every 6”(152mm) to provide superior fastening power.
- The work surfaces are high-pressure laminate that stand up to heavy use.
- Structural Framing — steel reinforcing beams attached to each leg — adding rigidity and preventing wobbly legs. Don't settle for Easy On Brackets for tables and desks in collaborative learning classrooms.



Shown in White Oak top with Cerulean edge and Platinum frame.

Interchange Wing Desk

This compact, contemporary desk designed for collaborative learning provides sleek looks, solid functionality and great flexibility. It can be arranged in countless ways for groups of all sizes. Its work surface provides ample space for work of all kinds. APAC has 4 laminate colors + 5 edgeband colors + 1 frame color but may add more in the future.

- Durable desktop available in 1 1/4”(32mm) or 3/4”(19mm) thickness, with a high-pressure laminate surface.
- Rugged powder coat surface on legs resists wear.
- Chrome-plated lower legs of 16-gauge steel resist scuffing.
- Sock-style glide caps add protection.
- 1”(25mm) adjustable leveling glides provide stability on uneven floors.
- Backpack hook is standard, attached to the structural framing of the Wing Desk.

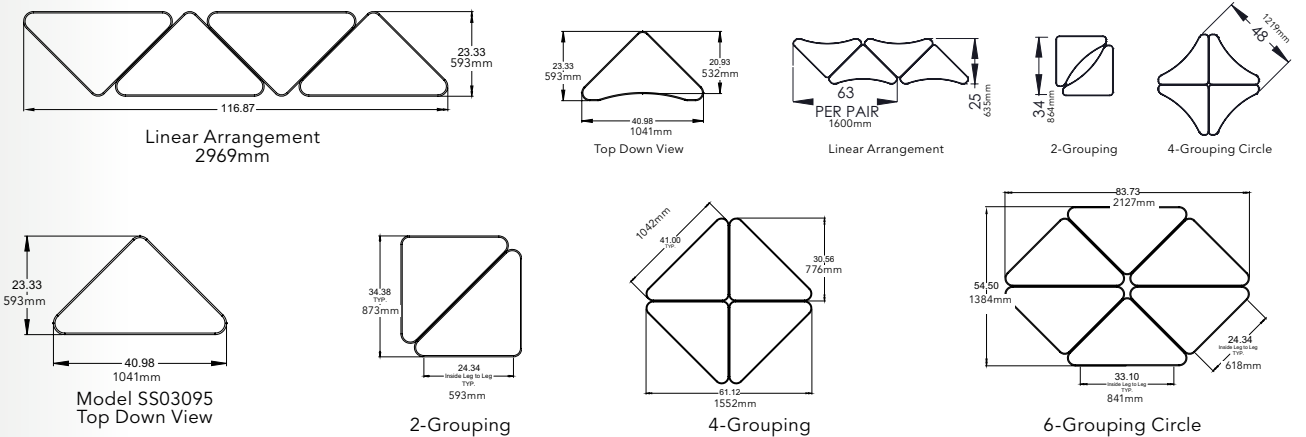

Diamond Wing Desk Model SS03095 available with optional Cascade® standard width tote.



Make it mobile with casters
Order Model 17576



Mix Wing & Swoop Wing Desks



Interchange Swoop Wing Desk

This compact, contemporary desk designed for collaborative learning provides sleek looks, solid functionality and great flexibility. It can be arranged in countless ways for groups of all sizes. The swoop in the work surface provides a sense of place for the student.



Interchange® Wing Desk



Wing Desks shown at 34"(864mm)h with 24"(610mm)h Flavors Fixed height Stools, Model 11889. Shown in Asian Night top with Apple edge and Platinum frame.



All Interchange Desks can be set at 34"(864mm)h on a glide or 37"(940mm)h on casters for use with a 24"(610mm)h stool or standing.



The unique shape of Interchange Wing Desks allows you to oppose desks in a compact area, or in rows for lectures, testing or individual work.



Shown in Classic Linen top with Persian Blue edge and Platinum frame. Shown with optional Flavors Stack Chair, Model 11849.

Interchange® Desks



Interchange Wing Open Front Desk
Model SS04503
 23.5" x 41" x 22" - 32" (597mm x 1041mm x 559mm - 813mm)
 Shown in White Oak top with Cerulean edge and Platinum frame.

Interchange Wing Open Front Desk

This flexible contemporary desk provides both sleek looks and solid functionality. Its space-saving desktop provides ample work space and allows it to create compact groups of four. It offers the convenience of a built-in Bookbox.

- Interchange Open Front Desks are made with your choice of bumper edge tops.
- Edge moldings resist wear, choices available (see chart, below).
- Rugged powder coat surface on legs resists wear.
- Chrome-plated lower legs of 16-gauge steel resist scuffing.
- Sock-style glide caps add protection.
- 1"(25mm) adjustable leveling glides provide stability on uneven floors.

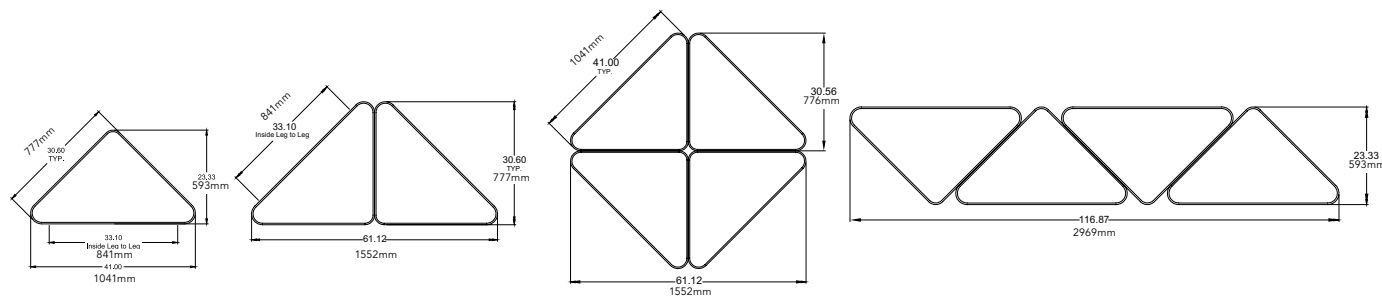

Shown in Classic Linen top with Apple, Cerulean, Platinum & Charcoal edges with Platinum frames. Shown with optional Oodle® stools, **Models OODLE31 CER, OODLE31 CGR & OODLE31 APL**

Optimize classroom space with Interchange Wing Desks.

Interchange Wing Desks allow great flexibility when it comes to creating compact pods of two, three and four students. The flexibility comes from the shape of the desktop. Its pie shape allows four students to work in a very compact area. Three students, even smaller. Two students can work almost side-by-side, facing or at an angle — whichever suits their activity.

Interchange® Desks



Six Interchange Diamond Desks form a compact group with ample space to work. Shown with optional Apple Casters, 17577.



Put two Interchange Diamond Desks together and students can work in a pair.



Three Interchange Diamond Desks approximate a semi-circle for three students.

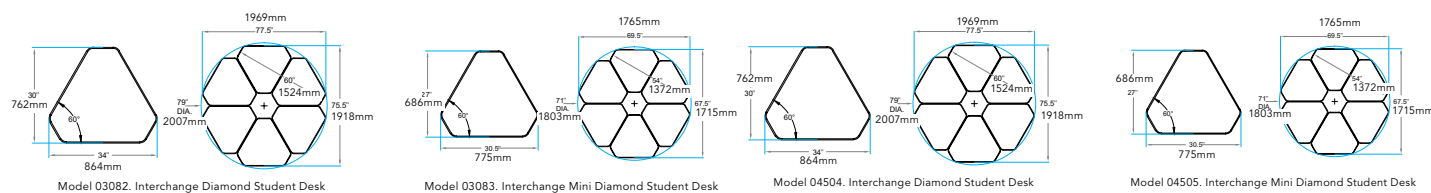

Interchange Diamond Desks

This contemporary desk designed for collaborative learning classrooms provides sleek looks and solid functionality. It can be arranged in compact groups of up to six. Its large work surface provides ample space for projects and work of all kinds.

- Durable desktop available in 1 1/4"(32mm) or 3/4"(19mm) thickness, with a high-pressure laminate surface.
- Edge moldings resist wear, choices available (see chart).
- Rugged powder coat surface on legs resists wear.
- 1"(25mm) adjustable leveling glides provide stability on uneven floors.
- Adjustable desk height, adjusts in 1"(25mm) increments. Only three (not four) legs to adjust on Single-Student Diamond Desk.



Crucial for desks in collaborative learning classrooms, Structural Framing provides a stronger work surface and prevents legs from wobbling.



Diamond Desk — Model 04504
Shown in Mocha Fir top with Apple Edge. Optional SW Tote (66013).



Make it mobile with casters
Order Model 17576

Interchange Diamond Mini Desk



Diamond Mini Desk — Model SS03083
available with optional tote and insert glides.



Tote Housing



Low Range Inserts on glides

Interchange Diamond Open Front Desks

This flexible contemporary desk provides both sleek looks and solid functionality. Its space-saving desktop provides ample work space and allows it to create compact groups of four. It offers the convenience of a built-in Bookbox,.



Model 04504
Shown in Flax Linen top with Apple edge and Platinum frame.



Model SS04504
Shown in Mocha Fir top with Apple edge and Platinum frame.

Interchange Diamond Open Front Desks

This flexible contemporary desk provides both sleek looks and solid functionality. Its space-saving desktop provides ample work space and allows it to create compact groups of four. It offers the convenience of a built-in Bookbox.

- Interchange Open Front Desks are made with your choice of bumper edge tops.
- Edge moldings resist wear, choices available (see chart, below).
- Rugged powder coat surface on legs resists wear.
- Chrome-plated lower legs of 16-gauge steel resist scuffing.
- Sock-style glide caps add protection.
- 1"(25mm) adjustable leveling glides provide stability on uneven floors.

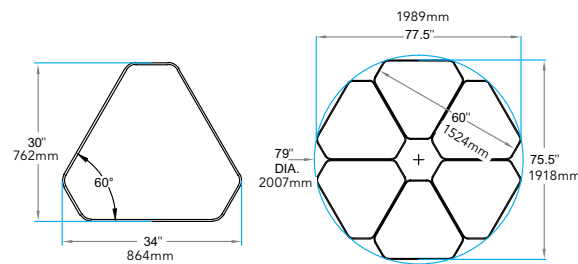

Model 04504. Interchange Diamond Student Desk

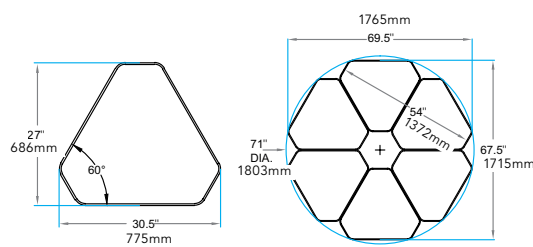

Model 04505. Interchange Mini Diamond Student Desk



Model SS04505
Shown in Grey Nebula top with Cerulean edge and Black frame.



Optimize classroom space with Interchange Diamond Desks.

Interchange Diamond Desks allow great flexibility when it comes to creating compact pods of two, three and four students. The flexibility comes from the shape of the desktop. Its pie shape allows four students to work in a very compact area. Three students, even smaller. Two students can work almost side-by-side, facing or at an angle — whichever suits their activity.

Interchange® Desks

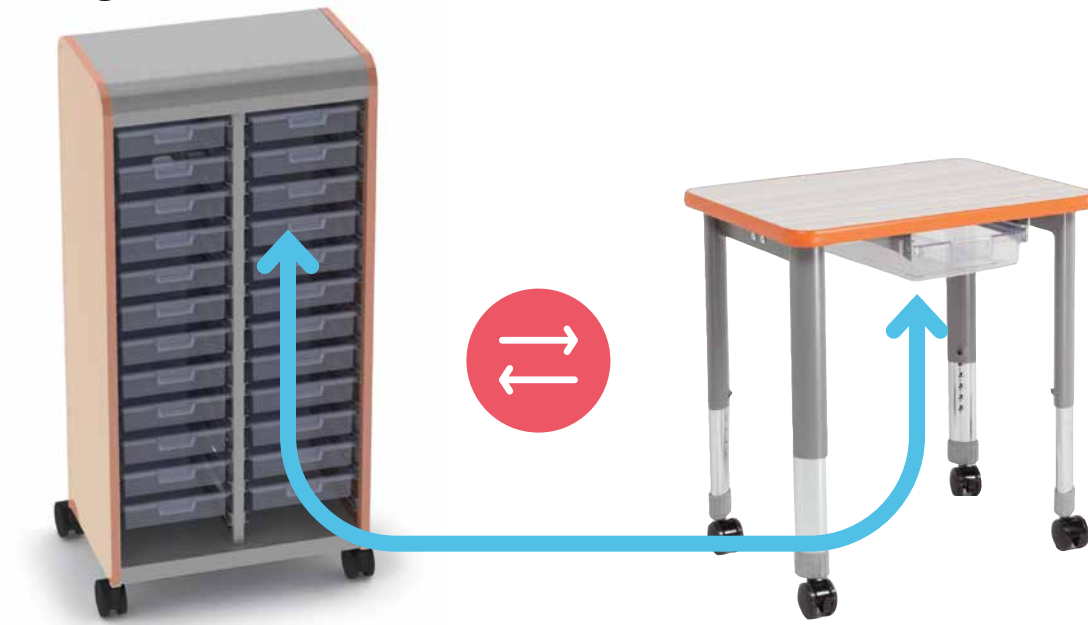

Compact and contemporary.

Cascade® totes available on select Interchange desk models. Cascade standard width (SW) tote is available on Interchange 20x27, Curve, Sequence®, Interchange 3-2-1 LS, Mini Diamond, Diamond, Two-Student Diamond and Wing desks.

Interchange 20x27 Desk, Model SS04080
Shown with optional Interchange SW Tote Tray with Housing Model 66013.



Interchange Wing Desk, Model SS03095
Shown with optional Interchange SW Tote Tray with Housing Model 66013.



Interchange Diamond Desk, Model SS03083
Shown with optional Interchange SW Tote Tray with Housing Model 66013.



Interchange Single-Student Desk, Model SS04080
Shown in High Rise top with Orange edge. Optional Interchange SW Tote Tray with Housing Model 66013. Optional Casters.



Single-Student Open Front Desk, Model SS04500
Shown in Mocha Fir Top with Platinum edge and Platinum frame.

Interchange® Desks

Interchange 3-2-1 Desk®

This versatile, contemporary table designed for collaborative learning provides sleek looks and solid functionality. The two-student desks can be arranged in many ways for both individual and group learning. Its work surface provides ample space for work of all kinds.

- Durable desk top available in 1 1/4"(32mm) or 3/4"(19mm) thickness, with a high-pressure laminate surface.
- Edge moldings resist wear, choices available (see chart).
- Rugged powder coat surface on legs resists wear.
- Chrome-plated lower legs of 16-gauge steel resist scuffing.
- Sock-style glide caps add protection.
- 1"(25mm) adjustable leveling glides provide stability on uneven floors.
- Adjustable table height in 1"(25mm) increments

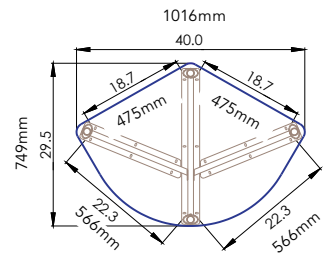

Model SS03002
Bottom View

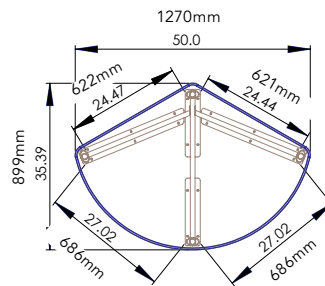

Model SS03011
Bottom View

Interchange 3-2-1 Desk in New Age Oak top and Apple edge with Flavors® seating in Apple.



Combine three 3-2-1 Desks and create a six-student group



Combine two 3-2-1 Desks for four students to work together



Four students can work at a single 3-2-1 Desk



Model SS04154
60"(1524mm) Table shown in Silver Grey top with Apple edge and Platinum frame..

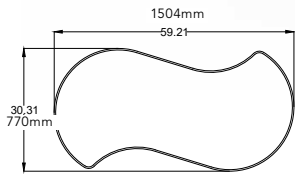

Model SS04154
seats 4

Interchange Squiggle Table

The Interchange Squiggle Table has an elegant curvilinear shape that when nested together create visually stimulating collaborative pods. These collaborative tables are a fun alternative to large rectangle tables when furnishing large spaces.



Model SS04152
Shown in Mocha Fir top with Cerulean edge and Platinum frame.

Interchange Cookie Table

The versatile Cookie table is a fun shape that can be arranged in a variety of creative ways. Use a single Cookie table or join multiple together for a larger footprint collaborative space. Constructed with Interchange® durability featuring oval shaped legs that are adjustable from 22"-34"(559mm-864mm) in 1 inch(25mm) increments.



Group of 3 Squiggle Tables



Group of 3 Squiggle Tables



Group of 4 Squiggle Tables

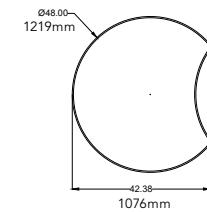

Model SS04152.
Interchange Cookie Table

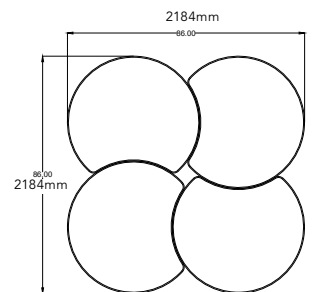

Seats eight



Model 04102
Shown in Arctic Walnut top with Cerulean edge and Platinum frame. Shown with optional low range leg inserts, Model 77159.

Interchange Rectangle Activity Table

This sleek, contemporary desk provides solid functionality and matches the look of Interchange student desks.

- Rugged frame of 1" x 2" (25mm-50mm) 14-gauge steel tube cross supports welded to 16-gauge elliptical tubes.
- Unique telescoping elliptical tube leg of 16-gauge steel adjusts height in 1" (25mm) increments.
- 14-gauge cross brace along the length of the table reinforces the strength of the table legs.

ADD CASTERS FOR MOBILITY

- Add easy mobility to Interchange tables with casters. Model 17576.



20"d x 60" (508mm d x 1524mm) Interchange Table, Model SS04085
Shown in Mocha Fir top with Charcoal edge and Platinum frame.



24"d x 60" (610mm d x 1524mm) Interchange Table, Model SS04102
Shown in Arctic Walnut top with Cerulean edge and Platinum frame.



30"d x 60" (762mm d x 1524mm) Interchange Table, Model SS04107
Shown in Silver Grey top with Apple edge and Platinum frame.

Interchange® Tables



Interchange SW Tote Tray
Model SS66013

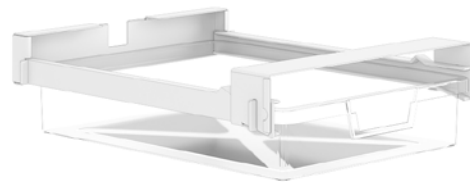

Interchange™ SW Tote Storage

The SW Cascade Tote Tray fits select Interchange™ Student Desks, see compatibility chart. Cascade Totes give teachers a versatile tool for organizing class materials. Whether it's by subject, lesson or student, materials can be assigned to a Tote. The Tote can either be kept in a Cascade Storage unit, or under the desktop of a desk outfitted with appropriate rails. Totes are clear ABS plastic, allowing quick visual inspection of materials. The totes can also be labelled.



Interchange Activity 48 Round Table
Model SS04125



Low Range Inserts on Glides
Model SS77159



**Interchange Half Moon Activity Table
Model SS04128**
36" x 72" x 22" - 34" (914mm x 1829mm x 559mm - 864mm)
Shown in Fusion Maple top with Chocolate edge and Platinum frame with optional casters, as well as 14" (356mm) and 18" (457mm) Plato Chairs.

Interchange Activity Table

These contemporary tables provide both sleek looks and solid functionality. Their large work surfaces provide ample space for projects and work of all kinds. Their look matches that of Interchange student desks.

- Rugged frame of 1" x 2" (25mm x 50mm) 14-gauge steel tube cross supports welded to 16-gauge elliptical tubes.
- Unique telescoping elliptical tube leg of 16-gauge steel adjusts height in 1" (25mm) increments.
- 14-gauge cross brace along the length of the table reinforces the strength of the table legs.



**Interchange Activity Half Moon Table
Model SS04128**
Shown in Arctic Walnut top with Charcoal edge and Platinum frame.



Elemental® Tables

Center leg design allows students to sit on both sides.



24" d x 60" (610mm d x 1524mm) Elemental Nest & Fold Table
Model SMEMTNL2460
Shown with Silver Grey top with Charcoal edge, Platinum adjustable leg set and Charcoal casters.



Fixed Height Table



Adjustable Height Table

Adjusts 29–40" h (737mm–1016mm)



Model SMEMTNL3060

Elemental Nest & Fold

Elemental Nest & Fold Tables provide a stable, spacious work surface and contemporary appearance. They offer added utility when not in use through their easy mobility and compact storage. Because they're part of an integrated line of tables and desking, they allow a consistent design scheme throughout the building or facility.

Elemental® Tables



Model SEMENTNL2448



Model SEMENTNL3060

Simple in form, these desks keep the focus on what matters most.



Silhouette Desk

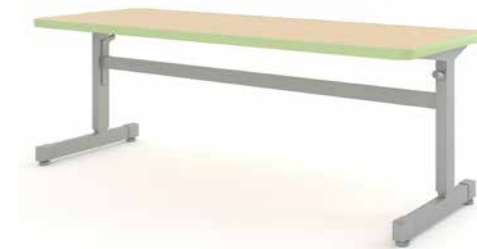

Two-Student Silhouette



Arc Desk

The standard desk that sets a new standard.

Stable.

The Silhouette desk is a contemporary, economic solution for all classrooms. Its durable cantilevered design, adjustable legs and optional storage accessories make it a timeless favorite. Single- and two-student options are available.

Strong.

It provides a notably strong surface that can withstand heavy loads and daily wear. A practical backpack peg is standard. Optional accessories include steel book box, wire book basket and Cascade® Storage tote trays.

Stunning.

Sometimes, elegant simplicity is all you need in a student desk. That's where Silhouette shines.





Silhouette Single-Student Desk, Adj
 20"d x 27" x 19-31" H(508mm d x
 686mm x 483-787mm H)
Model SMSLT01650
 Shown in Mocha Fir top with Charcoal
 edge and Platinum frame

Silhouette Desk — 18" and 20"(457mm and 508mm) Deep

The Silhouette Desk is a contemporary desk that combines elegant design, durability and functionality. It's stable and strong, and its leg design allows easy ingress and egress. A backpack peg is standard.

- Cantilevered design allows easy ingress and egress.
- Adjustable leg height from 19"-31"(483mm-787mm) in 1"(25mm) increments. Only two (not four) legs to adjust.
- Rugged powder coat surface on legs resists wear.
- Lockable endcap/glide combination that resists tampering.
- Choose from fixed-height or adjustable frame.



Model 01661. Shown in Asian Night top with Fuchsia edge and Platinum frame. A practical backpack peg is standard.

Model (2) 01650 and (1) 01661



Silhouette Single-Student Desk, Fixed
Model SMSLT01649
 Shown in Silver Grey top with Cerulean edge and Platinum frame

Silhouette Student Desk

The Silhouette Student Desk is a contemporary desk for both collaborative and traditional classrooms. It combines elegant design, durability and functionality. It's stable and strong and its leg design allows easy ingress and egress. Two backpack pegs are standard.



Model SMSLT01650
Silhouette Desk, adjustable-height



Model SMSLT01661
Silhouette Desk, adjustable-height



Model SMSLT01663
Silhouette Desk, fixed-height with glides

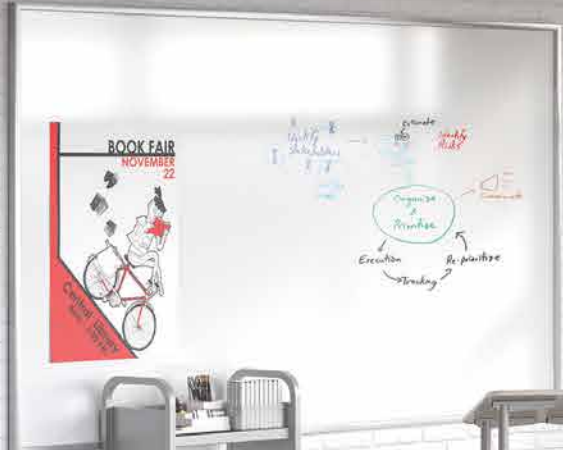



Silhouette Arc-8 Desk, adjustable-height
Model SMSLT01620

Silhouette Arc-8 Desk

Chosen for collaborative learning classrooms, the stable Arc-8 Desk offers ample workspace and exceptional ingress and egress to the student — crucial in an active classroom. This design saves time whenever she/he stands up or sits down.

- Leg shape allows easy ingress and egress for students.
- Desk height adjusts from 19"-31" (483mm-787mm) in 1"(25mm) increments. Only two legs to adjust.
- Durable desktop available in 1 1/4"(32mm) or 3/4"(19mm) thickness, all with a high-pressure laminate surface.
- Edge moldings resist wear, choices available (see chart).
- Rugged powder coat surface on legs resists wear.

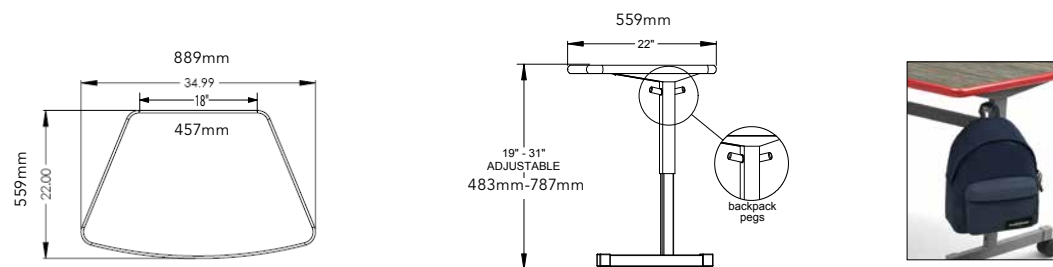

Patented backpack peg keeps student items organized, can be positioned inside or outside of either leg.

Create circular collaborative areas for students in groups of up to 8.



Silhouette Arc-8 Desks, Model 01620
Shown in Mocha Fir top with Cerulean edge.
Shown with optional casters and Flavors Stack
Chairs, 11849.

Silhouette® Accessories Desks



Fixed height
29.5" (749mm)

Fixed height,
with Caster,
29.5" (749mm)

Adjustable height on glide
19-31" (18" & 20"D) 483-787mm (457mm & 508mm D)
or 22-34" (24"D) 559-864mm (610mm D)

Sit, stand, roll, stop.
Multiple leg options
for multiple
classroom needs.



Silhouette Arc-8 Desk, Model SMSLT01620
Shown in Mocha Fir top with Cerulean edge
and Platinum frame



A line with a contemporary aesthetic, offering great breadth and versatility.



For a consistent design scheme.

This broad, highly customizable line can be used throughout the school. This allows you to maintain consistent colors, finishes and leg shapes, bringing unity to the school's décor.

For collaborative learning or traditional classrooms.

Silhouette Sit+Stand desks provide functionality and choice of height to collaborative learning classrooms.

Healthy construction.

UL GREENGUARD Gold Certified.

Model	Description	D"	W"	H"	WT.
Silhouette Sit+Stand Desk					
SMSLT01630/L	Silhouette Sit+Stand Small Rectangular Desk	20.4	28	26-41	41
SMSLT01631/L	Silhouette Sit+Stand Collaborative Desk	21.4	30	26-41	44
SMSLT01632/L	Silhouette Sit+Stand Large Rectangular Desk	20.4	28	26-41	44
Silhouette XL Sit+Stand Desk					
SMSLT01634/L	Silhouette XL Sit+Stand 24x30 Rectangle	24	30	26-41	48
SMSLT01635/L	Silhouette XL Sit+Stand 24x36 Large Rectangle	24	36	26-41	52.5

Low Pressure Laminate (with optional matching 2mm Edge Band):

- ARCTIC WHITE
- SEAGULL
- MERLE
- GRAPHITE WALNUT
- ACACIA
- MAPLE
- CLEAR WALNUT
- WARM ELM
- GREY OAK

High Pressure Laminate (with optional matching 2mm Edge Band):

- WHITE OAK
- ARCTIC WALNUT
- MOCHA FIR
- SILVER GREY
- WRITABLE TOP

Edge Color Options:

- APPLE
- CERULEAN
- CHARCOAL
- NAVY
- ORANGE
- PLATINUM
- RED

Leg Color:

- PLATINUM



* Technology Basket and Privacy Screen/Modesty Panel sold separately.

Silhouette® Sit+Stand Desks

**Silhouette Sit+Stand
Small Rectangle Desk**



Model SMSLT01630/L

**Silhouette Sit+Stand
Collaborative Desk**



Model SMSLT01631/L

**Silhouette Sit+Stand
Large Rectangle Desk**



Model SMSLT01632/L

**Silhouette XL
Sit+Stand Rectangle
Desk 24x30**



Model SMSLT01634/L

**Silhouette XL
Sit+Stand Rectangle
Desk 24x36**



Model SMSLT01635/L

Privacy Screen



Model 60099

For Desk Models 01630, 01631 and 01632

Model 60100

For Desk Models 01634 and 01635

Modesty Panel



Model 60099

For Desk Models 01630, 01631 and 01632

Model 60100

For Desk Models 01634 and 01635

Technology Basket

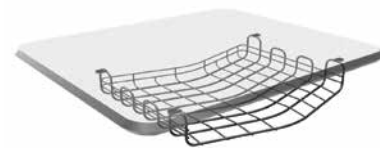

Model 76518



*Theorem®
Adjustable
Height
Stool*

*Theorem
Mobile Stack
Chair*

Maximum strength
and stability for a wide
variety of applications.



Studio Tables

Stable foundation.

What sets Planner desks and tables apart is their rock-solid bases.

- Steel legs, one at each corner, welded to two steel cross members at each corner.
- Heavy gauge steel modesty panel bolted to each leg across the front.

Unbeatable construction.

- T-Mold edge bands on Planner desks and tables are stapled every 6 inches (152mm) to provide superior fastening power.
- The work surfaces are high-pressure laminate that stand up to heavy use.

For collaborative learning or traditional classrooms.

- Huddle desks provide tremendous durability in collaborative learning classrooms.
- Planner student desks offer the same strengths in traditional classrooms.

Healthy construction.

- SCS Indoor Air Advantage™ Certified.

Offering flexibility, functionality and mobility.

- Planner student desks are available in a variety of sizes including two- and three-student models.
- Huddle desks are available in three sizes.
- Built-in backpack pegs keep classrooms tidy.
- Steel Bookboxes and caster sets available.

Planner activity tables' versatility is a strength.

- Work surfaces available in Trapezoid, Square, Round, Half-Moon and Contour shapes.
- Trespa® TopLab® Plus surfaces available for labs and art rooms.
- Modesty panels available.

Dependability.

- Lifetime warranty on the frame and legs, 12-year warranty on table and desktops.



Planner® Studio Tables



Planner Studio Tables — 36"(914mm) Deep

These tables are designed to meet the needs of today's creative learning spaces. These sophisticated 29"(737mm) h, 36"(914mm) h, 40"(1016mm) h tables meet the demanding needs of your Makerspace, without the pared down "shop-class" aesthetics.

The adaptive urban industrial style allows for crossover application in media centers, active learning spaces, common areas or any space that encourages collaboration and social learning.

- Strong, 14-gauge steel legs are protected with a durable powder coat surface.
- Sturdy 1 1/4"(32mm) desktop with a high-pressure laminate surface.
- 3mm flat edges.
- 3 top colors and 5 leg color choices. 30"(762mm) D Platinum leg only.
- Optional second surface shelf kits available on stand-up models 36" & 40"(914mm & 1016mm), in Grey only.
- Optional foot rest available for 36"(914mm) height Studio tables, Platinum finish only.
- Planner Studio comes standard with 4"(102mm) diameter casters, with all 4 wheels lockable.

Tables that meet the demanding needs of today's creative learning spaces.



36"d x 60"w (914mm d x 1524mm w)
Planner Studio, Model SMPLN25210
40"(1016mm) h, Shown in Trespa Black top with Platinum legs.

Planner Studio Tables — 36"(914mm) Deep Trespa®

The Planner Studio table with Trespa TopLab top is designed to meet the needs of demanding creative and science learning spaces. The 1/2"(6mm) thick work surface consists of Trespa TopLab® PLUS material, which is resistant to a large number of aggressive chemicals as identified by SEFA (Scientific Equipment and Furniture Association) and PSI (Professional Services Industries), if cleaned within 24 hours.

- Strong, 14-gauge steel legs are protected with a durable powder coat surface.
- Trespa Planner Studio is available in 36x60" (914mm x 1524mm) size only.

Planner® Studio Tables



**36" d x 60" w (914mm d x 1524mm w) Planner Studio,
Model SMPLN25208**
36" h (914mm h), Shown in White Oak top with Cerulean edge
and Platinum legs. With Charcoal casters.



**36" d x 60" w (914mm d x 1524mm w) Planner Studio,
Model SMPLN25206**
29" h (737mm h), Shown in Mocha Fir top with Orange
edge and Platinum legs. With Charcoal casters.

Planner® Studio Tables



**36"d x 72"w (914mm d x 1829mm w) Planner Studio,
Model SMPLN25212**
29"h (737mm h), Shown in Mocha Fir top with Cerulean
edge and Cerulean legs. With Charcoal casters.



**36"d x 72"w (914mm d x 1829mm w) Planner Studio,
Model SMPLN25214**
36"h (914mm h), Shown in Mocha Fir top with Apple
edge and Apple legs. With Charcoal casters.

Planner® Studio Tables



36" d x 72" w (914mm d x 1829mm w) Planner Studio,
Model SMPLN25216
40" h (1016mm h), Shown in Silver Grey top with Apple
edge and Platinum legs. With Charcoal casters.



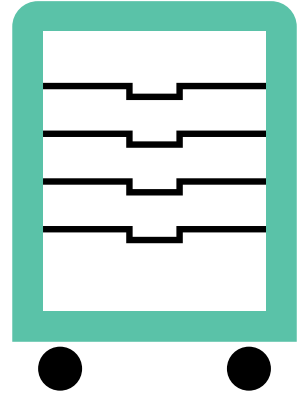

Storage

Imagine a classroom where four or five groups of six students are working on projects. The teacher circulates about, providing information, direction and encouragement. To allow for all this activity, materials and resources must be organized and readily available to students. Independent access to resources for students frees the teacher to direct and instruct as needed. That's the idea behind Cascade.

Built for Learning.





Storage that holds your attention, too.



Model 57AAA00000
Straight Unit w/shelves and no back panel.



Model 57BBAC18000
Curved Unit w/totes, shelves and back panel.



Model 57BBAC18000
Curved Units w/totes, shelves and back panels, three shown.

Whiteboard Back available. Choose model with back panel. The optional magnetic whiteboard back panel is not needed to increase rigidity. When no back panel is installed, the unit has a pass-through design for access from both sides.

Model	Description	D"	W"	H"	WT.
57AAB27000	Straight Unit w/27 3" SW totes - no back panel	19	53	40	279
57BAB27000	Straight Unit w/27 3" SW totes and back panel	19	53	40	308
57AAA00000	Straight Unit w/shelves - no back panel	19	53	40	231
57BAA00000	Straight Unit w/shelves and back panel	19	53	40	261

Model	Description	D"	W"	H"	WT.
57BAC18000	Curved Unit w/18 3" SW totes & shelves - no back panel	24	59	40	296
57BBAC18000	Curved Unit w/18 3" SW totes & shelves & back panel	24	59	40	328
57BAA00000	Curved Unit w/shelves - no back panel	24	59	40	272
57BBAA00000	Curved Unit w/shelves and back panel	24	59	40	304

Standard Vinyl Color Options:

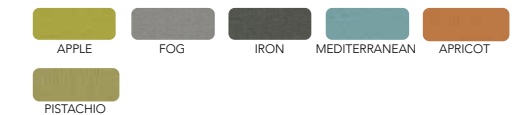

* Apricot, Fog, Iron, Mediterranean, and Pistachio have matching end caps. All others will have Platinum end caps.

3mm Edge		Surface Options:	
Top & Bottom Panels 1 1/4"		FRENCH PEAR	
Vertical Panels & Shelves 3/4"		MISSION MAPLE	
		NORTH SEA GRAY	





Model SMSFS57BL
Curved Unit w/totes and shelves and back panel. Shown in Mediterranean end panel and French Pear laminate.



Flowform Curved Storage

Flowform Storage adapts to nearly any environment, the sides blend to create a versatile storage system. Available in 3 laminate choices, with matching 3mm-edge end panels finished in wrapped vinyl in choice of 5 colors — plastic handles match the vinyl colors. The end panels are a 16-gauge steel interior shell, wrapped in a cushioned vinyl exterior. The tubular steel sub-frame is constructed of 14-gauge steel, which supplies the unit solid construction. The end panels are capped off with a plastic handle that is color matched to the vinyl of your choosing.



Curved Unit w/shelves



Whiteboard Back Available.
Choose model with back panel.

Flowform Vinyl End Panel – Poly End Cap

- Pistachio **PIO**
- Mediterranean **MDT**
- Iron **ION**
- Apricot **APR**
- Fog **FGO**

Make room

3 Sizes. Towers, cabinets or mini-case.



Cabinets



Towers



Mini Case

Teacher tote storage and transfer.

Cascade® totes can transfer between Teacher Storage and Desk.



Model R10006062PP
Cascade Teacher Wardrobe with casters.
Open with SW totes. Available for order in US.

Student tote storage and transfer.

Cascade totes containing student work can transfer directly from the storage unit to under-desktop and back.



Model 910W3600P

Cascade® Storage System

Tailored to every school room and curriculum.

- Eleven sizes
- Casters or glides
- Totes, shelves or cubbies
- Available in Platinum coat color
- White board back on Mega-Tower size

Cascade Cases

Equip your Cascade Case with tote trays to hold a wide variety of learning materials. Add utility with an optional riser shelf and lectern.



Mini-Case

Mid-Case



Cascade Cabinets

Available with tote trays, it holds a wide variety of learning materials. Optional riser shelf and lectern make this perfect for presentations.



Mid-Cabinet

Mega-Cabinet



Cascade Towers

Available with tote trays, it holds a wide variety of learning materials. Provides maximum capacity and can be configured many ways.



Mini-Tower

Mid-Tower

Mega-Tower



Cascade Cabinets

Available with shelves, it holds a wide variety of learning materials. Optional riser shelf and lectern make this perfect for presentations.



Mid-Cabinet

Mega-Cabinet



Cascade Towers

Available with shelves, it holds a wide variety of learning materials. Provides maximum capacity and can be configured many ways.



Mid-Tower

Mega-Tower



Cascade® Storage System

A customizable system for organizing, storing, distributing and presenting materials.

Arc, Huddle®, Silhouette®, Planner® and Interchange® Desks



**Interchange Wing Desk,
Model 03095**
Shown with a SW Tote Tray, Model 66013.



**Interchange 20x27"
(508x686mm), Model 04080**
Shown with a SW Tote Tray, Model 66013.



To learn more, watch the Cascade Storage Video:
smithsystem.com/cascade-storage

Cascade Mega-Cabinet

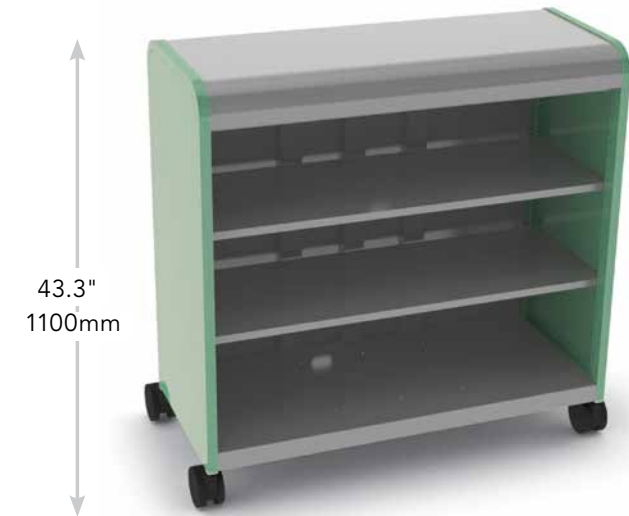

Model B1100000PH
Mega-Cabinet with casters
Open with shelves



Model 91100000P
Mega-Tower with casters
Open with shelves

Cascade® Mega Tower

Cascade Mega-Tower



Model 911W00000P
Mega-Tower with casters
Open with shelves



Model 910036000P_
Open w/ thirty-six 3"(76mm) SW totes



Model 910009093PP
Mega-Tower with casters
Open with SW totes



Model Model 910W09150PP
Mega-Tower with casters
Open W/9 x 3" & 15 x 6" (W/229 x 76mm) &
(381 x 152mm) SW Totes



Model C10W24000PP
Mega-Tower with casters
Open W/24 x 3" (W/610 x 76mm) EW Totes

Cascade® Cabinets

43.3"
1100mm



Model B11W00000P
Mega-Cabinet with casters
Open with shelves



Model 610W24000P
Mega-Cabinet
Open with W24 x 3"(W/610 x 76mm) SW totes



Model 610W12060PP
Mega-Cabinet
Open W/24 x 3" & 6 x 6" (W/610mm x
76mm) & (152mm x 152mm) SW Totes



Model B10W16000PP
Mega-Cabinet
Open W/16 x 3" (W/406 x 76mm) EW Totes

Cascade® Cases

Cascade Mini-Case

These compact, versatile, mobile storage units are available with either tote trays or shelves and can be fitted with numerous options including locking doors, and a riser shelf. Our Cascade Storage System allows educators to organize, store and distribute learning materials. These mobile storage units are highly customizable to hold items in a wide range of sizes and shapes — from sheets of paper to art supplies.



Model 110V05000P
Mini Case
Open W/5 x 3"(W/127 x 76mm) EW Totes



Model 121V00000P
Mini Case
Door with shelves

Cascade® Whiteboard



Available on any Mega-Tower
or Mega-Cabinet Unit.



Steelcase | Smith System®

www.steelcase.com/asia-en/smith-system/

