

Product tear sheet

COLUMN h/a

Height adjustable workstation base system with shared middle legs and integrated services reticulation.

Motor: dual, with smooth and low noise operation.

Control pad: USB-C charging module, digital display with 3 memory functions and timer option.

Safety considerations: up and down anti-collision settings to 8 sensitivity levels. 30mm threshold between tops. Low- and high-level limit pre-set or locked height option. System overheating protection.

Warranty: 5 years on parts and labour, with extended options available on request.

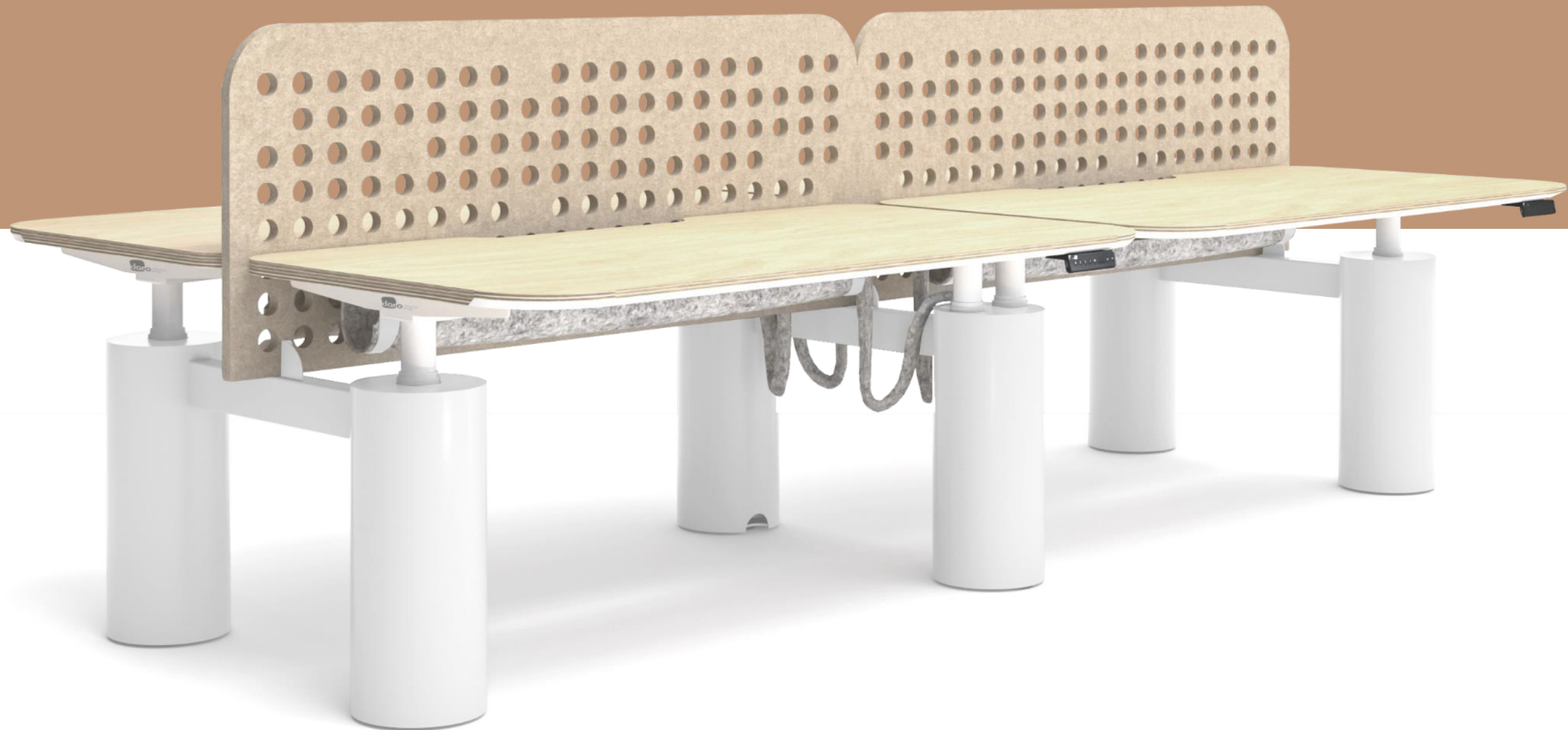

Product tear sheet

Configuration: clusters of back-to-back.

Height range: 640-1290mm + top.

Top width: 1400-2100mm.

Speed: 38mm/s.

Load capacity: 120kg.

Lead time: 2 - 4 weeks.

Origin: China.

Base finish: Black or white satin powder coat, with custom colour options available to 219mm dia. drums and cross bars.

Top finish: to client specification.

Screen Finish: 24mm thick spine or 12mm thick individual PET panel screens, house range or as specified.

Screen options Spine screen:

Recommended
Max FFL
1400mm

Cluster of 2

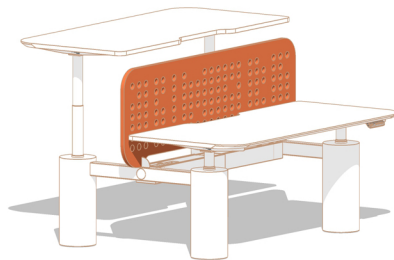

Cluster of 4

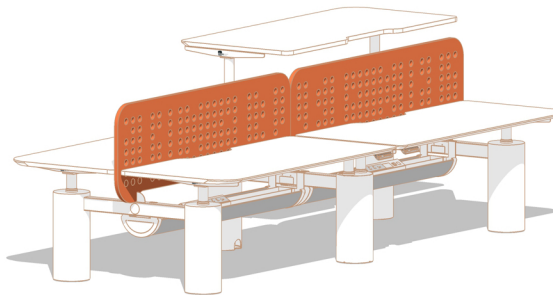

Cluster of 6 +

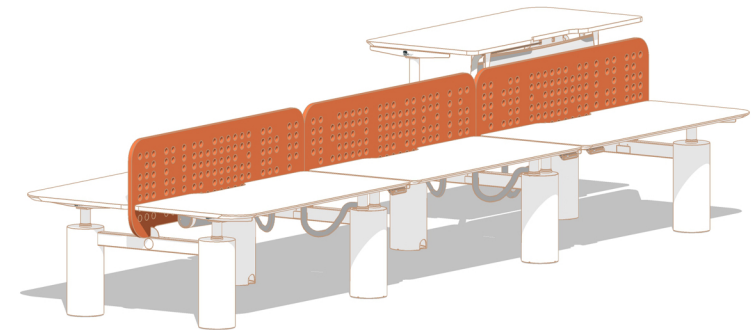

Individual screen:

Recommended
Max FDL
450mm

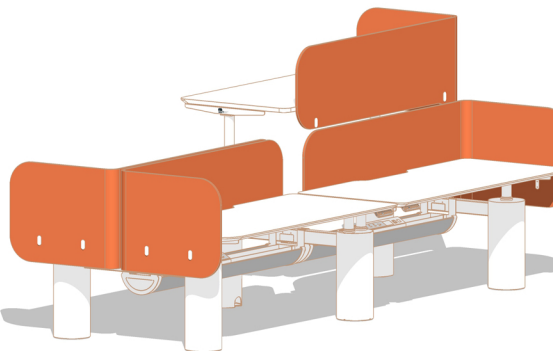
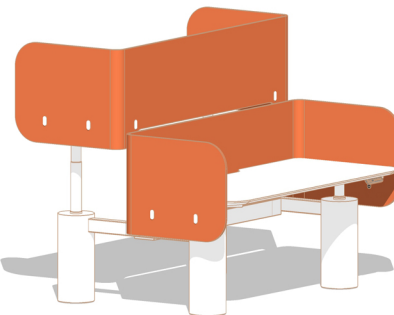

Product tear sheet

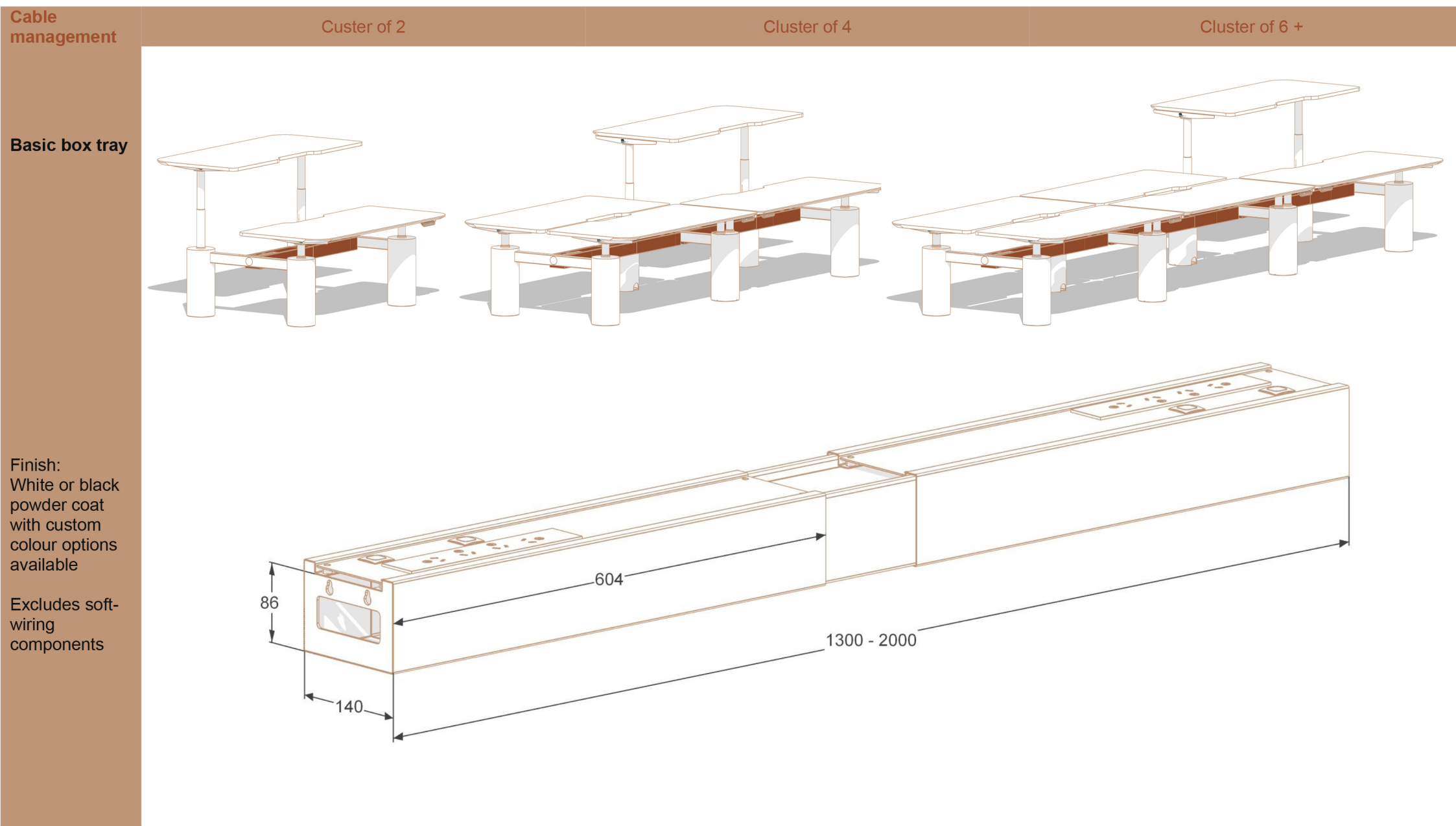

Cable management

Cluster of 2

Cluster of 4

Cluster of 6 +

Basic box tray

Finish:
White or black powder coat with custom colour options available

Excludes soft-wiring components



Product tear sheet

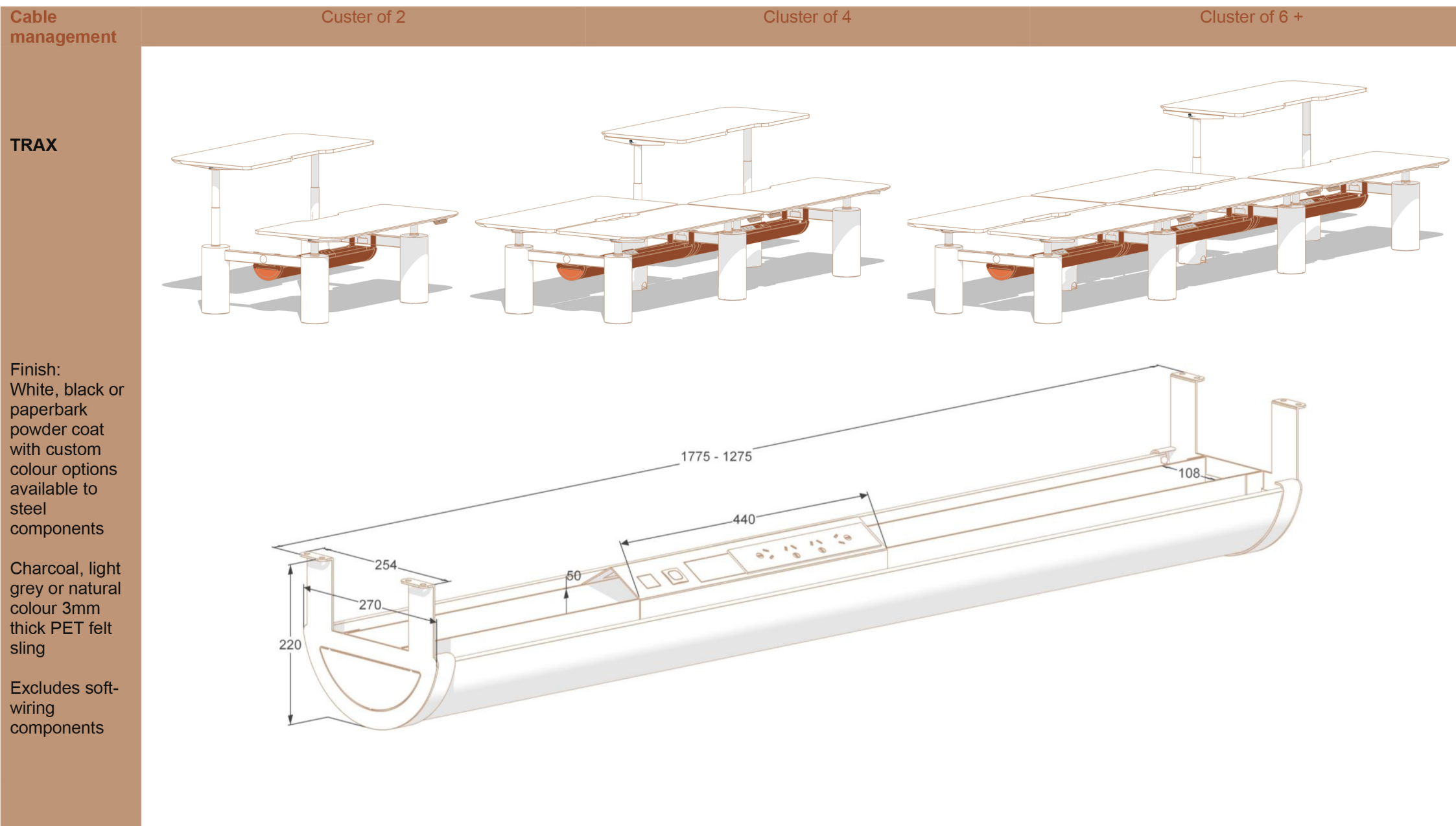

Cable management

Cluster of 2

Cluster of 4

Cluster of 6 +

TRAX

Finish:
White, black or
paperbark
powder coat
with custom
colour options
available to
steel
components

Charcoal, light
grey or natural
colour 3mm
thick PET felt
sling

Excludes soft-
wiring
components



Product tear sheet

Cable management

Cluster of 2

Cluster of 4

Cluster of 6 +

TRAX lite

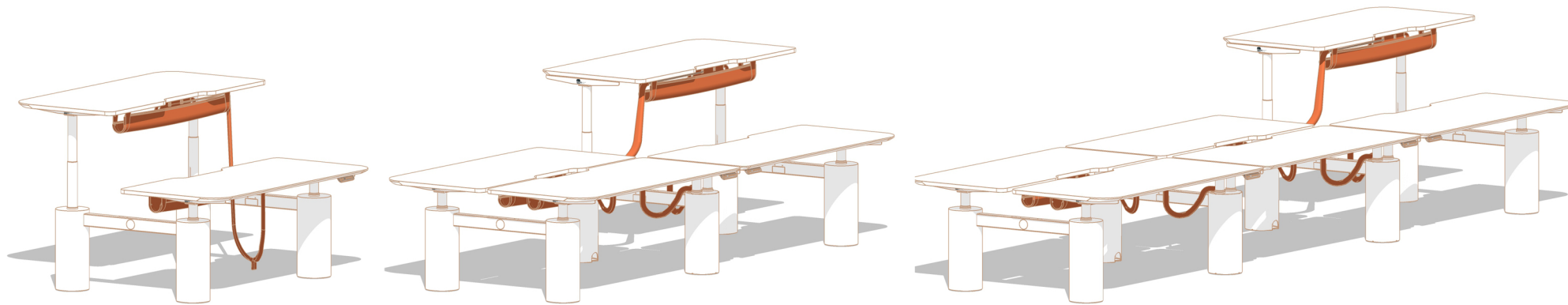

Finish:
White, black or
paperbark
powder coat
with custom
colour options
available to
steel
components

Charcoal, light
grey or natural
colour 3mm
thick PET felt
sling

Excludes soft-
wiring
components

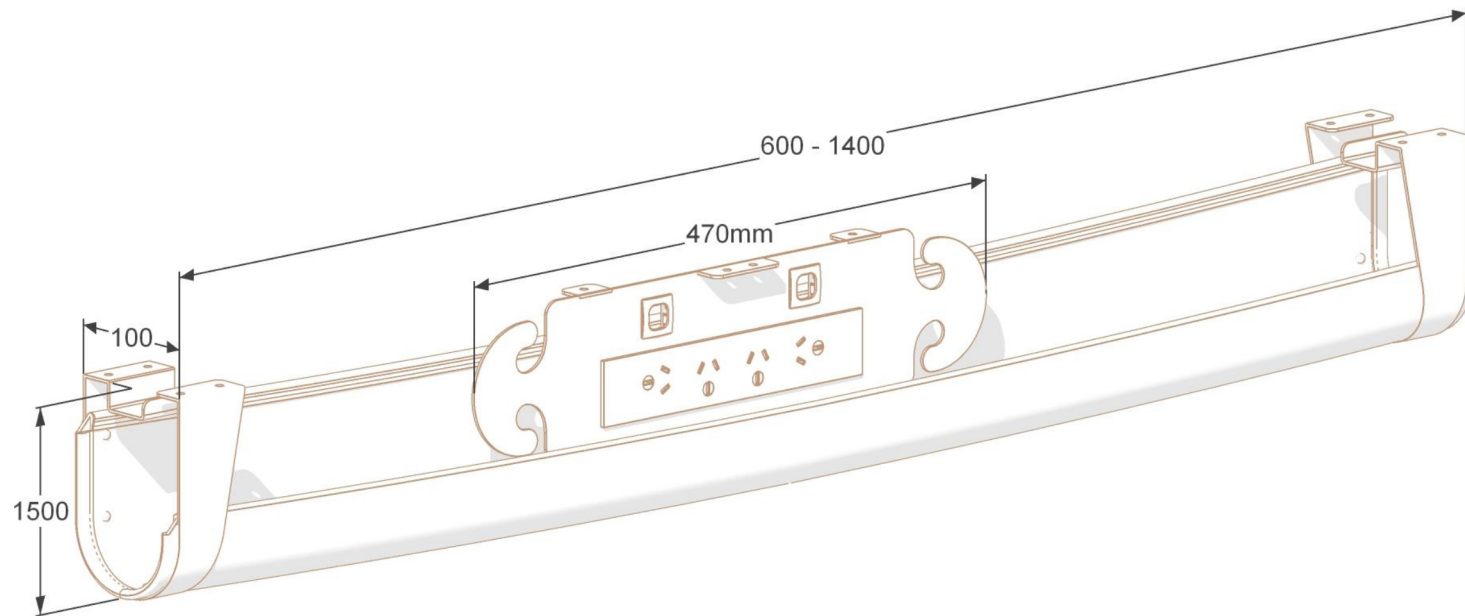





Call: [0410528300](tel:0410528300)

Visit: [shop 2, 263 Enmore Rd, Enmore, NSW 2044](https://www.klarodesign.com.au)

Email: alona@klarodesign.com.au

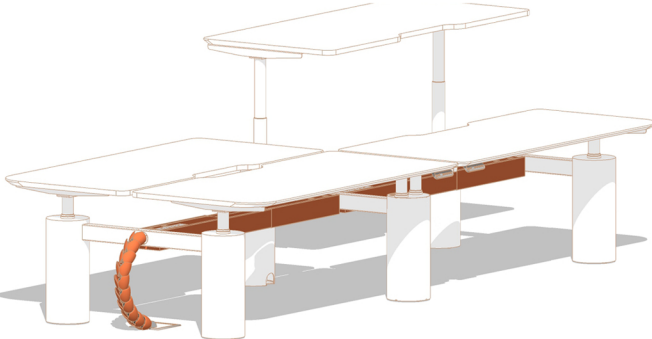
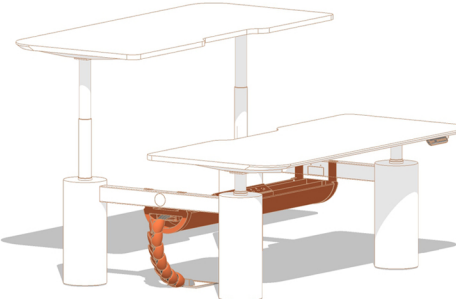

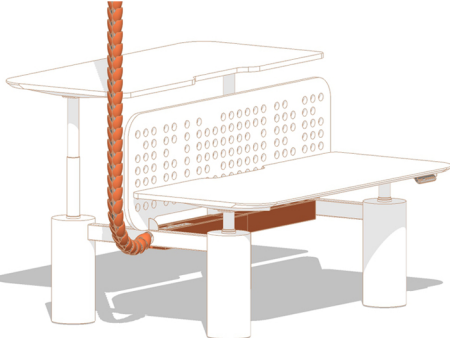
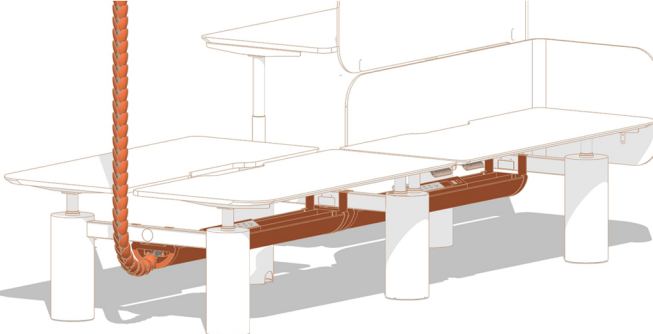
Product tear sheet

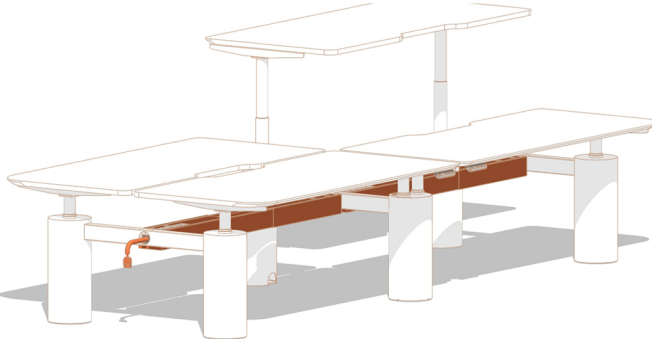
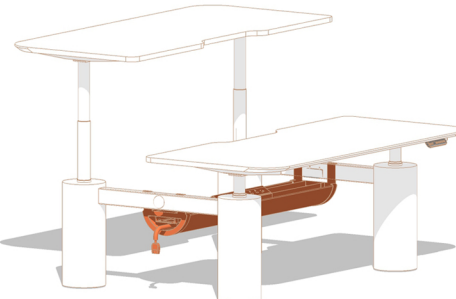
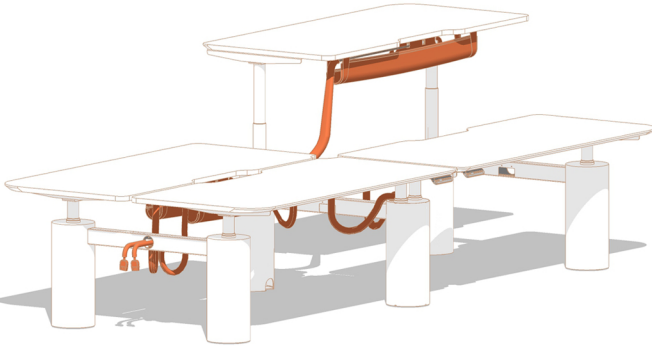
Services access location	With BASIC box tray	With TRAX	With TRAX lite
Floor			
Ceiling			
Wall			



Product tear sheet

COLUMN h/a
Frame
measurements
And
clearances

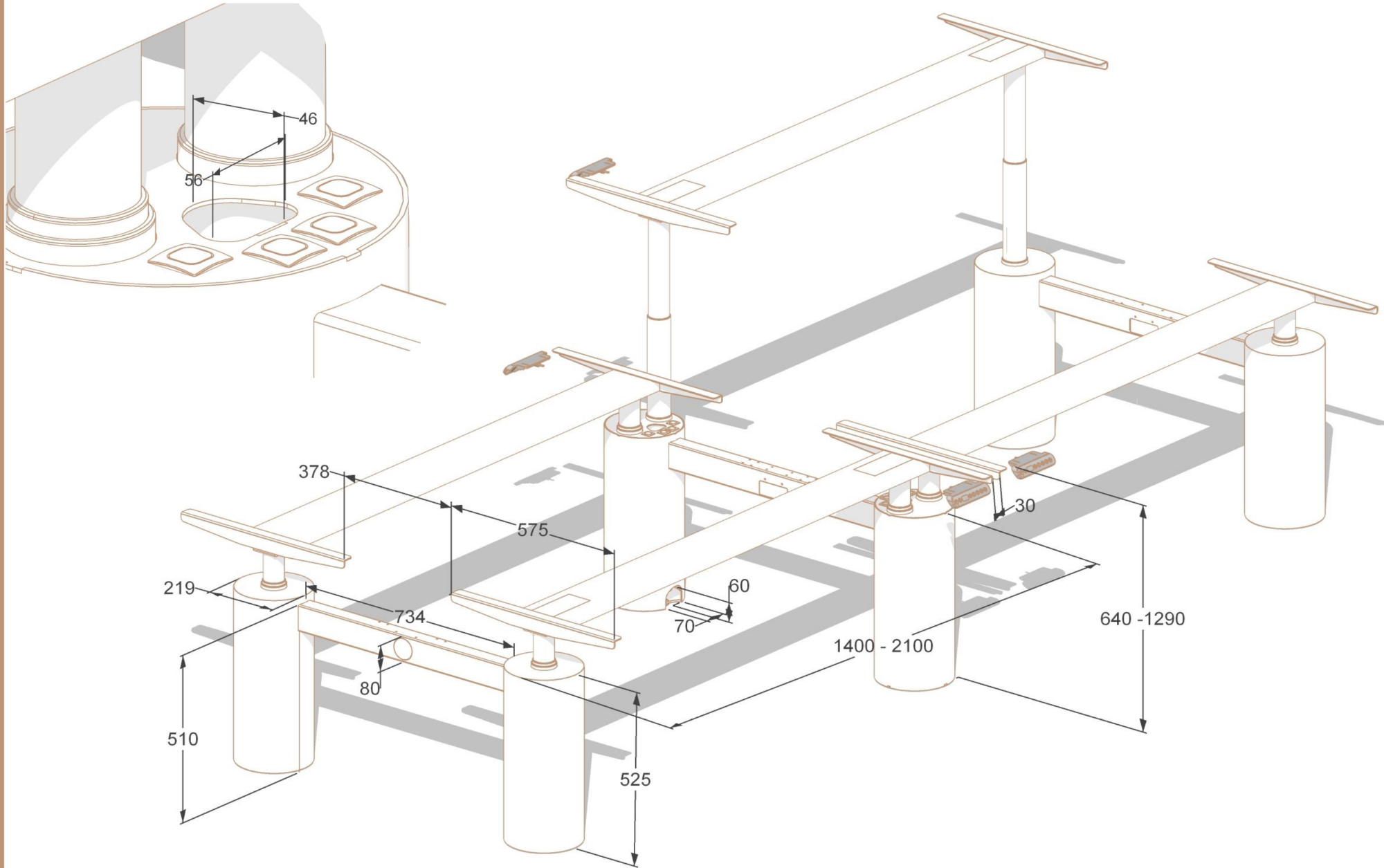

Product tear sheet

COLUMN h/a Accessories

Screen bracket, tension stay or screw fix panel mounting

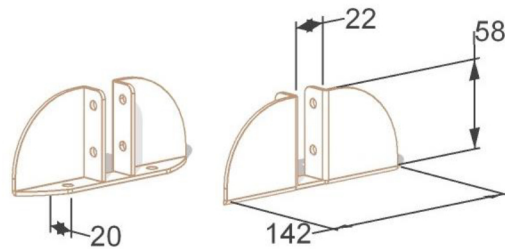

Finish: white or black powder coat with custom colour options

Services management sock, complete with velcro, loop and eyelet

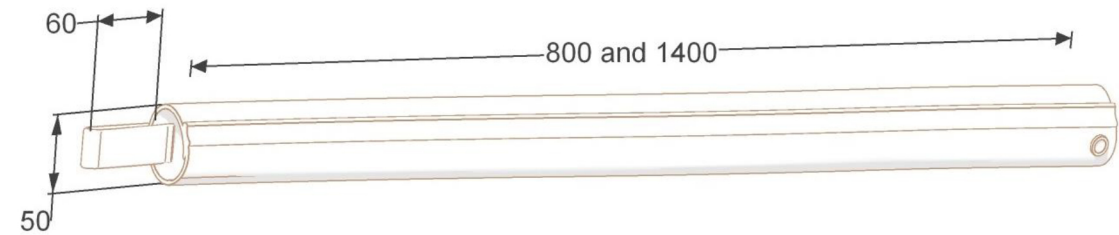

Black or light grey fabric, or to client specification

Environmental considerations:

- all mild steel parts are fully recyclable through normal channels.
- take back policy in place on all electric parts.
- expanded polystyrene is replaced with honeycomb cardboard packaging.
- PET panels and accessories parts are made from 70% recycled material.
- Simple assembly with screw fixings allows for easy refurbishment or knock down and relocate.

